

Hybrid Hydraulic System
[ECO-RICH R]

EHU30R-M0701-10

EHU30R-M0702-10

EHU15R-M0701-10

EHU15R-M0702-10

Operation Manual



DAIKIN INDUSTRIES, LTD.

Oil Hydraulics Division

<Safety Precautions>

■ Before using this product

- Give consideration to make users thoroughly understand the contents of this operation manual.
- Please incorporate the contents of this operation manual in operation manuals for your machine using this product.
- To ensure proper operation of this unit, be sure to read this operation manual and all other attached documents carefully, to have a thorough understanding of the equipment, safety information and all other precautions before installation, operation and maintenance/inspection of this unit.
- Be sure to keep this operation manual, attached documents and delivery specifications in place, so that you can read them whenever required.
- For detailed explanation of the unit, all figures and photographs included in this manual show the unit without covers or safety shields. To operate this unit, be sure to mount the covers and shields in the specified manner, and observe the operating procedures described in this manual.
- The contents of this operation manual are subject to change appropriately for product improvement, specification change or easier operations.
- This operation manual should be used as a reference that provides safety instructions for DAIKIN Hydraulic Unit. In addition to this manual, please prepare safety references for your machine to ensure safe operations and maintenance in accordance with various standards and norms.

■ Conventions of safety instructions in this manual

- In this manual, safety instructions are classified into three categories: “▲ DANGER”, “▲ WARNING” and “▲ CAUTION”.

▲ DANGER: Improper handling regardless of this indication causes an urgently hazardous condition that may result in death or serious injury.

▲ WARNING: Improper handling regardless of this indication causes a potentially hazardous condition that may result in death or serious injury.

▲ CAUTION: Improper handling regardless of this indication causes a potentially hazardous condition that may result in medium or slight injury, or property damage.

Even an item indicated as “▲ CAUTION” may result in a serious accident depending on the situation. All instructions given in this manual include important information. Be sure to observe all of them.

■ Safety precautions

◆ General precautions

▲ DANGER

- Transportation, installation, piping, wiring, operations, maintenance and inspections must be conducted by qualified personnel.
- During the above work, wear protective gear required for safe work (work clothes, safety band, helmet, safety shoes, gloves and so on).
- Do not use this unit under conditions other than those specified in the catalog or delivery specifications.

▲ CAUTION

- Be sure to conduct daily inspections (described in this manual or attached documents).
- Do not apply external force to this unit. (Do not step on, or pound on this unit.) Otherwise, you may suffer from injury, or the unit may be damaged.

<Escape Clauses>

- DAIKIN shall not be responsible for any damage attributable to a fire, earthquake, third party's action and other accidents, as well as customer's intention, misuse or use under abnormal conditions.
- DAIKIN shall not be responsible for any damage incidental to use of this product or impossibility to use this product (loss of business profit, discontinuation of business).
- DAIKIN shall not be responsible for any accident or damage attributable to negligence in observing the instructions given in the operation manual or delivery specifications.
- DAIKIN shall not be responsible for any damage attributable to malfunction caused by combinations of this unit and external equipment.

<Limitations on Applications>

- If a failure or malfunction of this unit may directly threaten human life, or this unit is used for equipment that may cause injury to the human body, such an application must be considered depending on the case.
- This unit has been manufactured under strict quality control. However, when it is used for important equipment, the equipment must be provided with a safety device to prevent malfunction of this unit from resulting in serious accident or damage.

Contents

[1. Introduction]	5
[2. Features and Structure]	5
[3. Description on Model Identification Code]	6
[4. Specifications and Operating Conditions]	7 to 8
[5. Precautions for Use]	8
[6. Names of Unit Components]	9
[7. Hydraulic Circuit]	10 to 11
■ Hydraulic circuit diagram	
■ Components	
■ Piping	
[8. Precautions for Transportation and Installation]	12 to 13
■ Precautions for transportation	
■ Precautions for installation	
[9. Preparations for Operation]	10 to 23
■ Filling hydraulic oil	
■ Electric wiring	
■ I/O signal cable specifications	
[10. Test Run]	24
[11. Operation Panel Operating Procedure]	25 to 36
■ Outline of functions	
■ Description on individual modes	
■ Shift between individual modes	
■ Operating procedure for each mode	
a) Monitor mode	
b) Setting mode	
c) Alarm mode	
■ Alarm code display list	
[12. Maintenance]	36 to 40
[Attachment: Safety Valve Adjustment Procedure]	41 to 43
[Attachment: Power-ON External I/O Signal Timing Chart]	44 to 50

[1. Introduction]

Thank you for selecting **IPM Motor Drive Hydraulic Unit <ECO-RICH R>**.

Using the oil hydraulic technology and energy-saving IPM motor drive system that DAIKIN originally developed, the **IPM Motor Drive Hydraulic Unit <ECO-RICH R>** provides overwhelmingly excellent energy conservation performance and advanced functions.

Before using the **EHU R Series <ECO-RICH R>**, please read this manual thoroughly, and handle and maintain this unit properly, so that this unit can retain excellent performance for a long period.

The components of this unit may be modified for the purpose of quality/performance improvement or other reasons. In such a case, some parts of this product may be different from those described in this manual.

[2. Features and Structure]

- Multi-stage speed control/Multi-stage pressure control, and shockless control functions
 - The Hydraulic Unit enables multi-stage pressure control/flow rate control by selecting 4 patterns of P-Q characteristics that have been registered in the controller from the master machine (via a contact input).
 - The Hydraulic Unit enables shockless control by setting/adjusting the rising/falling time at changes of the P-Q characteristics.

[3. Description on Model Identification Code]

(a)	(b)	(a)		(c)	(d)	(e)		(f)		(g)
EHU	**	R	-	M	**	**	-	**	-	*****

- (a) Series name
 - EHU**R: EHU R series
- (b) Maximum pump discharge rate
 - 15: 15.2 L/min
 - 30: 28.5 L/min
- (c) Output characteristic
 - M: See the chart below.
- (d) Maximum operating pressure
 - 07: 7.0 MPa
- (e) Tank capacity
 - 01: 10 L
 - 02: 10 L
- (f) Design No.
 - Advances according to model change.
- (g) Non-standard control No.

MFG. No

(h)	(i)	(j)		(k)
*	*	**	-	**_*****

- (h) Design No.
- (i) Hardware revision history
- (j) Software revision history
- (k) Serial No.

<Output characteristic>

[EHU30R-M07]

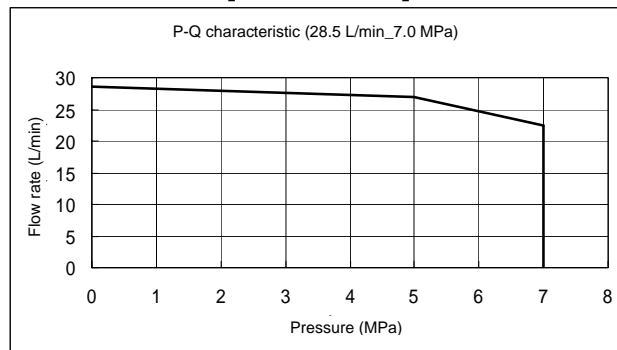

[EHU15R-M07]

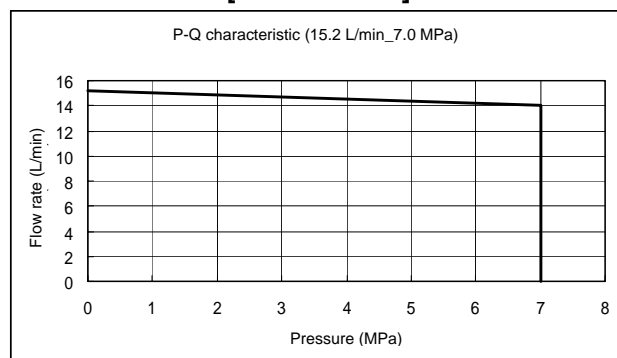

[4. Specifications and Operating Conditions]

■ Major specifications

		EHU30R-M07	EHU15R-M07
Maximum operating pressure	(MPa)	7.0	
Maximum discharge rate ^(Note 1)	(L/min)	28.5	15.2
Operating pressure adjusting range	(MPa)	0.5 to 7.0	
Operating discharge rate adjusting range ^(Note 1)	(L/min)	3.4 to 28.5	3.4 to 15.2
Power supply ^(Note 2)		3φ 200V/50Hz, 200V/60Hz, 220V/60Hz	
External input signal	(3ch)	Photo-coupler insulation, 24 VDC (27 VDC max.) 5 mA/ch	
External output signal	Alarm output (1ch)	Relay output Contact capacity: 30 VDC, 0.5 A (Resistance load) 1c contact	
	Digital output (2ch)	Photo-coupler insulation, open-collector output, 24 VDC, 50 mA max./ch	
Standard paint color		DAIKIN black (equivalent to Munsell code N-1)	

■ Control performance

		EHU30R-M07	EHU15R-M07
Command acceleration/deceleration adjusting range	(sec/MPa) (sec/1000min ⁻¹)	0.01 to 9.99	
Minimum control flow rate ^(Note 3)	(L/min)	3.4 ±0.34	
Control flow rate repeatability	(MPa)	1% or less of maximum discharge rate	

(Note 1)

- Before shipment from the factory, the unit has been set to the maximum discharge rate. (The maximum discharge rate is a theoretical value, not a guaranteed value.)
- For details on the factory settings, see the initial values given in the setting range table on **p. 31**. For other specifications, see **the delivery specification drawing (model drawing)**.
- The upper limit of the pressure adjusting range is higher than the maximum operating pressure. However, make sure that the pressure setting does not exceed the maximum operating pressure shown above.
- This hydraulic unit incorporates a safety valve, which has been set to work at maximum operating pressure + 0.5 MPa.

The safety valve has been set to approx. 7.5 MPa.
To change the setting of the safety valve depending on the withstanding pressure of the hydraulic circuit being used or for other reasons, refer to **“Safety Valve Adjustment Procedure” on p. 41**.

(Note 2)

- Power supply voltage fluctuation tolerance range is ±10%. Even if the power supply voltage fluctuations are within the tolerance range, when the power supply voltage fluctuates in the positive direction, the regenerative overload (alarm stop) may occur in response, depending on the master machine operating conditions and load conditions.

(Note 3)

- The minimum speed varies depending on each unit. Adjust the minimum speed setting individually.

■ Operating conditions

Hydraulic oil ^(Note 4)	Dedicated mineral hydraulic oil / Wear-resistant hydraulic oil (For recommended brands, see DAIKIN “Hydraulic Equipment General Catalog (HK196)”.) <ul style="list-style-type: none"> • Viscosity grade: ISO VG 32 to 68 • Viscosity range: 15 to 400 mm²/s • Pollution degree: NAS Class 10 or lower level
Tank oil temperature	0 to 60°C (Recommended operating temperature range: 15 to 50°C) ^(Note 5)
Operating ambient temperature	0 to 35°C
Storing ambient temperature	-20 to 60°C
Humidity	85% RH or less
Installation place	Indoor (Be sure to fasten the unit with bolts.)
Others	<ul style="list-style-type: none"> • Be sure to mount a no-fuse breaker and earth leakage breaker. • Make sure that the electric wiring conforms to European Norm EN60204-1. • If you frequently turn ON/OFF the power supply for this unit, the controller service life will be remarkably deteriorated. If you intend to start and stop the unit frequently, use the control stop function of this unit. • Be sure to connect the ground terminal.

(Note 4)

- This unit can use only mineral hydraulic oil. (Water-containing or synthetic oil such as water-glycol cannot be used.)

(Note 5)

- When the tank oil temperature exceeds the recommended operating temperature range, pressure pulsation may be increased, or the discharge rate may be decreased. However, such phenomena do not indicate abnormality.

[5. Precautions for Use]

- (1) The motor pump of this hydraulic unit is mounted via vibration suppressing rubber that prevents motor pump vibration from being conveyed to the unit.
The pump should be connected to the unit with a hose.
- (2) To cool hydraulic oil and the motor, this hydraulic unit is equipped with an AC fan. To ensure spaces for air intake and exhaust, do not place an obstacle at 10 cm or shorter distance from the end surface of the unit.
- (3) This hydraulic unit uses an IPM motor, which generates counter-electromotive force during changeover (regenerative operation). If the motor is frequently turned ON/OFF in the operating condition that easily generate counter-electromotive force, it causes regenerative overload, resulting in unit stop.

- (4) This hydraulic unit is equipped with a safety valve.

This safety valve has been set to a specified pressure before shipment. However, during long-term repeated operations of the unit, or because of contaminants in hydraulic oil, the preset pressure of the safety valve may decrease.

If the unit is continuously operated with the safety valve activated, it may activate the alarm due to a temperature rise and so on. In this case, readjust the safety valve pressure setting according to “Attachment: Safety Valve Adjustment Procedure” on p. 41.

In order to suppress surge pressure for protection of peripheral equipment (actuator for the main unit, pressure gauge, etc.), it is recommended that the safety valve setting should be “Preset pressure of the unit + 0.5 MPa”.

[6. Names of Unit Components]

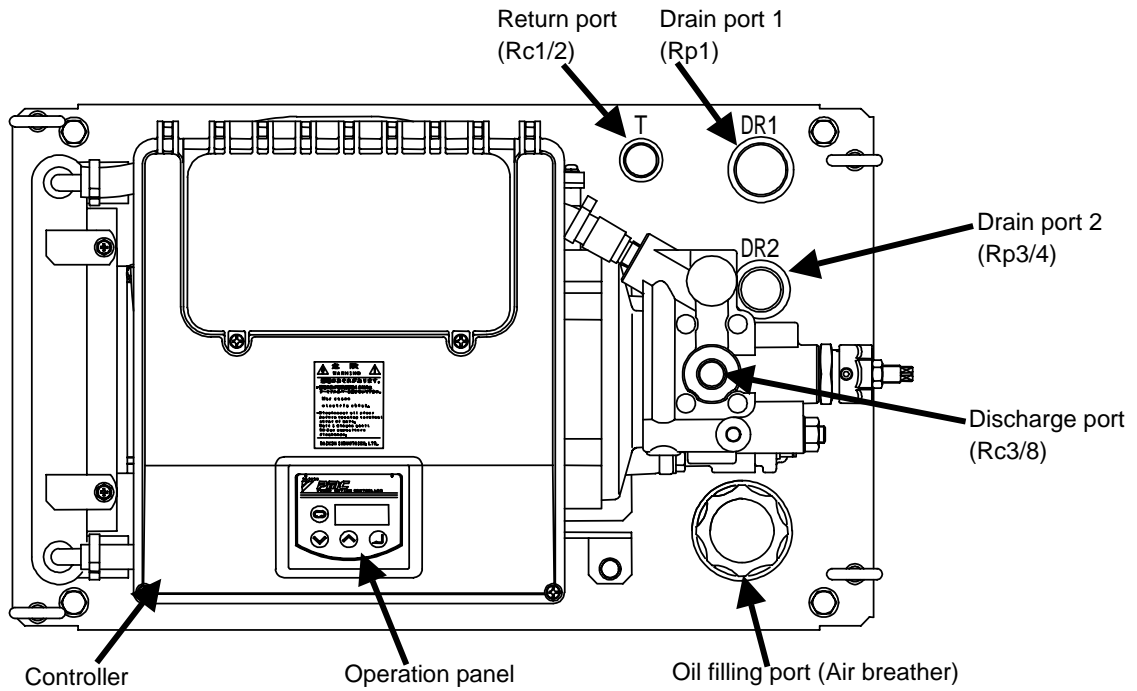

<Unit top view>

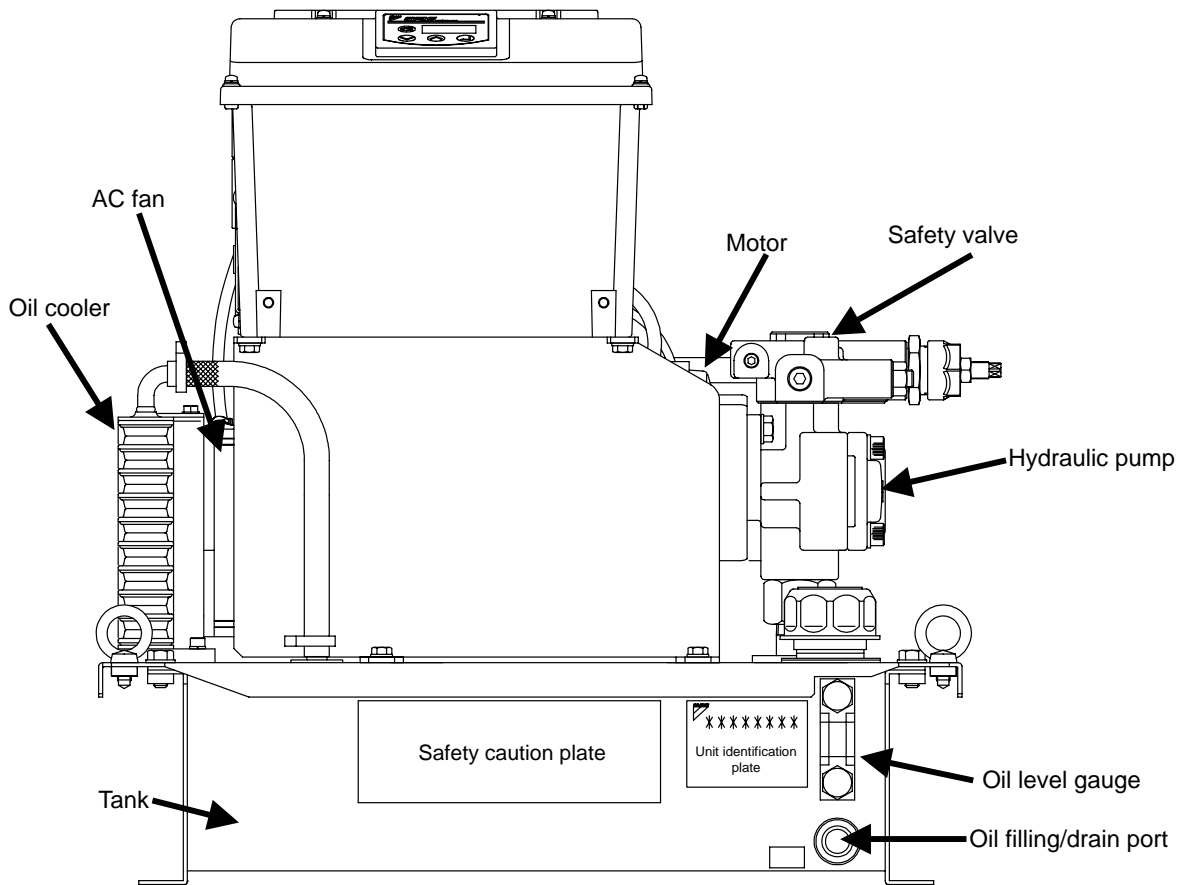

<Unit front view>

[7. Hydraulic Circuit]

■ Hydraulic circuit diagram

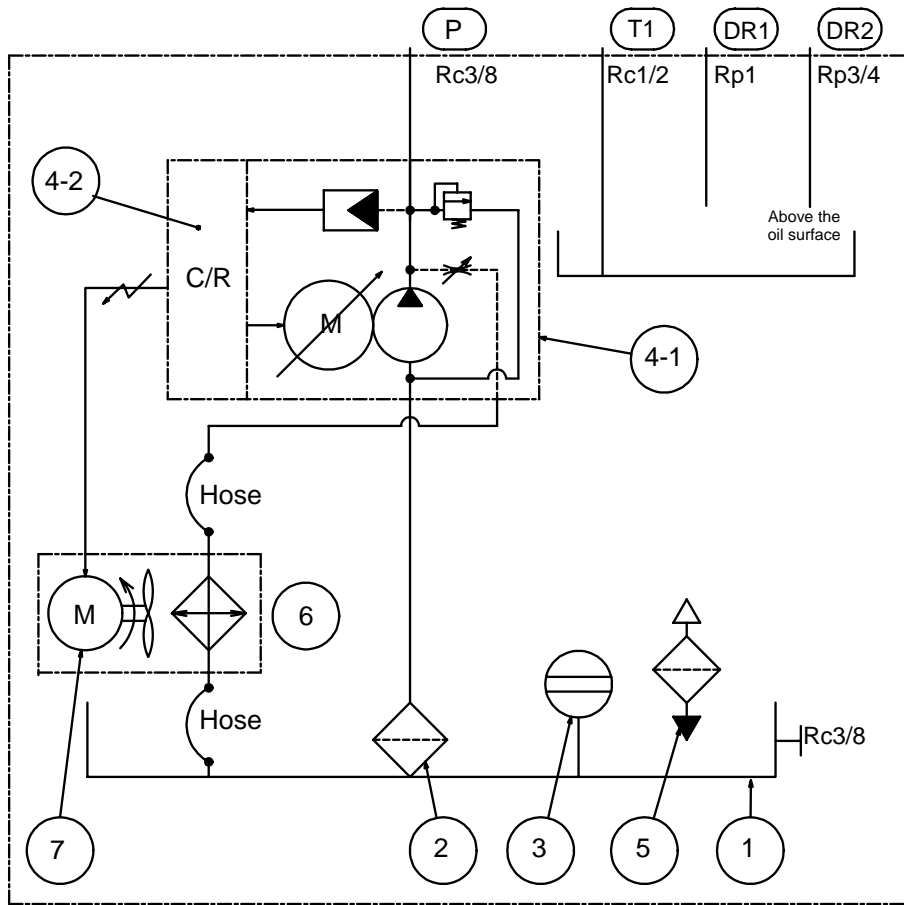

■ Components

Part No.	Name
1	Tank
2	Suction strainer
3	Oil level gauge
4-1	Inverter drive pump
4-2	Controller
5	Oil filling port (Air breather)
6	Oil cooler
7	AC fan

■ Piping

This hydraulic unit is equipped with one return port (submerged in the oil), two drain ports (above the oil surface) and one discharge port. Connect pipes with these ports as required.

Each piping port has been covered with tapered cap (vinyl cap) before shipment.

Fasten each pipe connection by winding sealing tape.

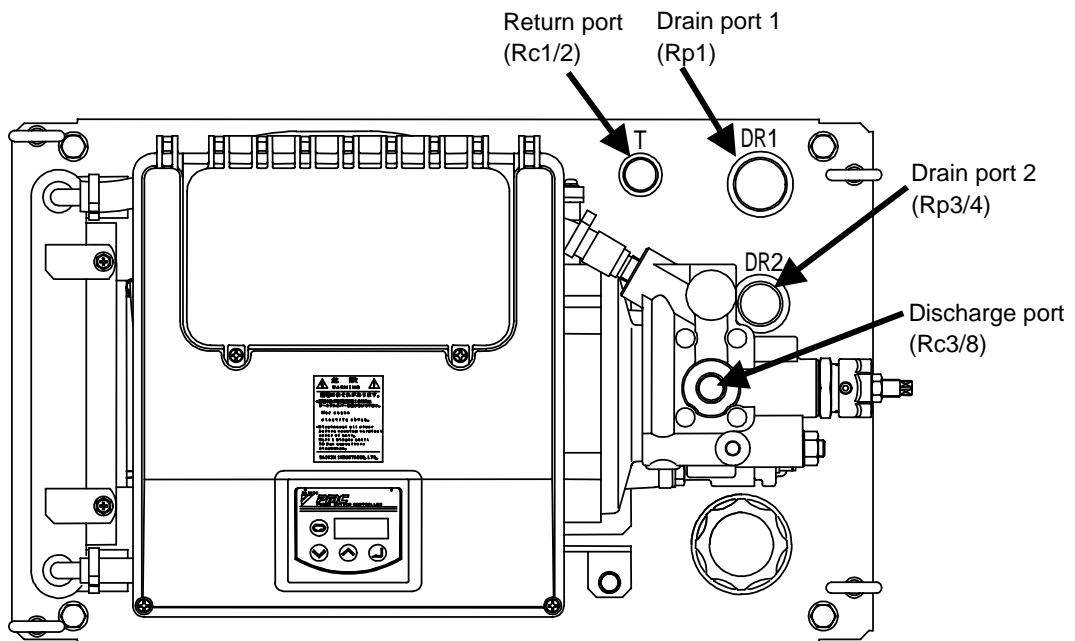

<Unit top view>

[8. Precautions for Transportation and Installation]

■ Precautions for transportation

- To lift this unit, be sure to use the eyebolts (at four places).

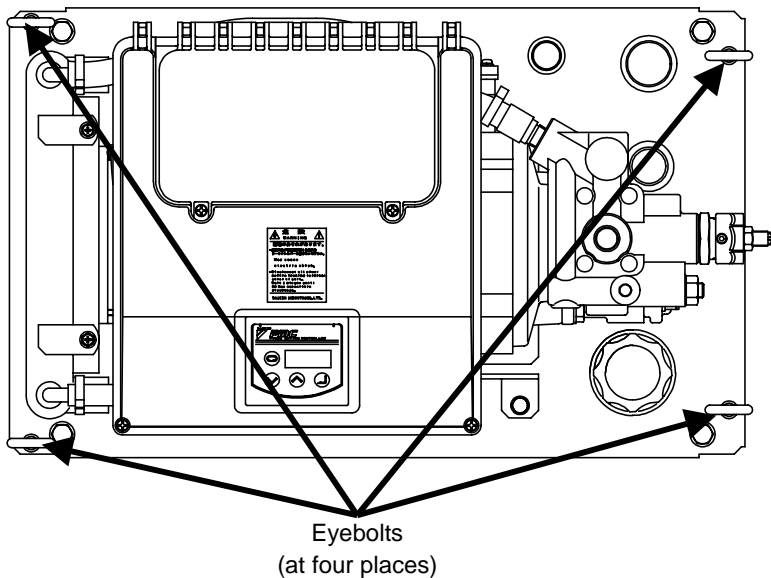

▲ DANGER

- If the hydraulic unit is lifted with any parts (e.g. pump piping) other than the eyebolts, the unit may fall or turn over.
- Check the weight of the hydraulic unit, and make sure that it does not exceed the rated load capacity of each lifting sling.

▲ WARNING

- During transportation, make sure that the unit is lifted with the eyebolts evenly at four places.
- During transportation using lifting slings, never come close to the unit. If the unit falls or turns over, you may suffer from injury.

▲ CAUTION

- Avoid transporting the hydraulic unit with hydraulic oil contained in the tank.
(This may cause oil leak, or malfunction due to air intrusion.)
- During transportation, hold the hydraulic unit securely so that it will not be moved by vibration or external force.

<Weight table> (Hydraulic oil is not included)

Model	EHU30R-M0701	EHU15R-M0701	EHU30R-M0702	EHU15R-M0702
Weight	41 kg	39 kg	42 kg	40 kg

■ Precautions for installation

◆ Securing air intake/exhaust space

Do not place an obstacle that blocks the oil cooler's air intake or air exhaust within 10 cm from the unit end surface.

Install the unit in a well-ventilated place to prevent the area around the unit from being stuffed with hot air. Make sure that the intake air temperature does not exceed the specified ambient temperature range (**35°C or lower temperature**).

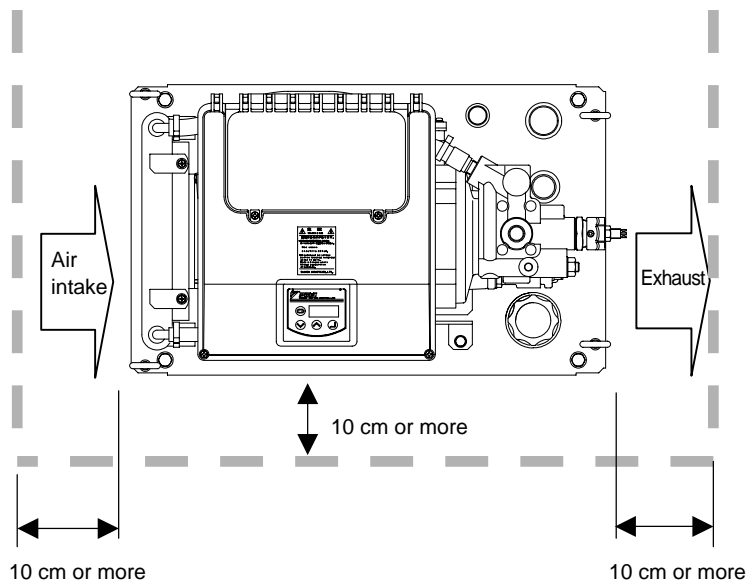

▲ WARNING

- If the hydraulic unit is used in a place without an air intake/exhaust space, or where hot air is stuffed around the unit, the oil cooler/AC fan's heat exchanging function will deteriorate, causing the hydraulic oil or equipment to become extremely hot.
- If you accidentally touch the hot parts, you may get burns.

▲ CAUTION

- If the hydraulic unit is used in a place without an air intake/exhaust space, or where hot air is stuffed around the unit, the motor and controller become hot, causing the equipment service life to be remarkably shortened.
- When the motor or controller becomes hot, the temperature protection function is activated to stop operation. (When the motor or controller becomes extremely hot, the alarm/warning signal will be output.)
- If the hydraulic unit is continuously used at a high temperature, the hydraulic equipment (pump, valves, etc.) will have defects or shortened service life, as well as the electric components described above.
- Using the hydraulic unit at a high temperature accelerates deterioration of the hydraulic oil, resulting in shortened service life.

◆ Fastening onto a level plane

- Install the hydraulic unit on a level base or level floor.
- Fasten the hydraulic unit securely so that it will not shake.
- For the installation procedure and location, see the delivery specification drawing (model drawing).

▲ WARNING

- Unless the hydraulic unit is fastened with bolts, it may be turned over or moved by reaction force under the oil pressure in the pipe.

▲ CAUTION

- If the hydraulic unit is installed on an inclined plane, oil leak or air intrusion occurs, resulting in abnormal sound or shortened service life of the equipment.
Be sure to install the unit on a level plane.

[9. Preparations for Operation]

■ Filling hydraulic oil

- Remove the cap of the oil filling port (air breather) by turning it counterclockwise, and fill clean hydraulic oil (**pollution degree: NAS Class 9 or lower level**) into the tank. Set the oil level so that the float of the level gauge is between the red and yellow lines.
- Use the hydraulic oil conforming to the operating conditions specified on p. 8.

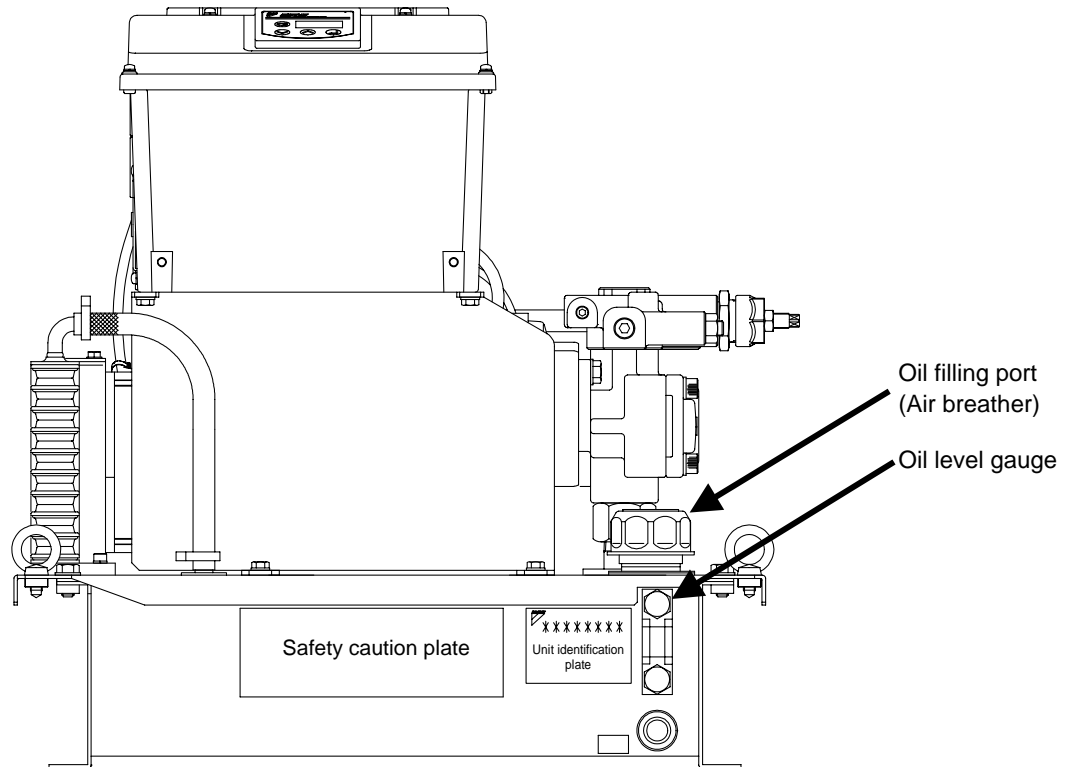

Unit model	Tank capacity (L)	Oil level setting range	
		Yellow line (upper limit)	Red line (lower limit)
EHU30R-M0701-10 EHU15R-M0701-10	10	10 L	7 L
EHU30R-M0702-10 EHU15R-M0702-10	20	20 L	14 L

▲ CAUTION

- [1] Operating the hydraulic unit with no oil in the tank causes pump seizure or wear, which may result in pump damage.
- [2] During initial operation of the machine, oil will be supplied into the hydraulic circuit of the machine. Be careful about a decrease in oil level in the tank.
- [3] The oil level in the tank may largely fluctuate depending on the machine hydraulic circuit. This may result in oil leak from the tank, or decrease in oil level.

■ Electric wiring

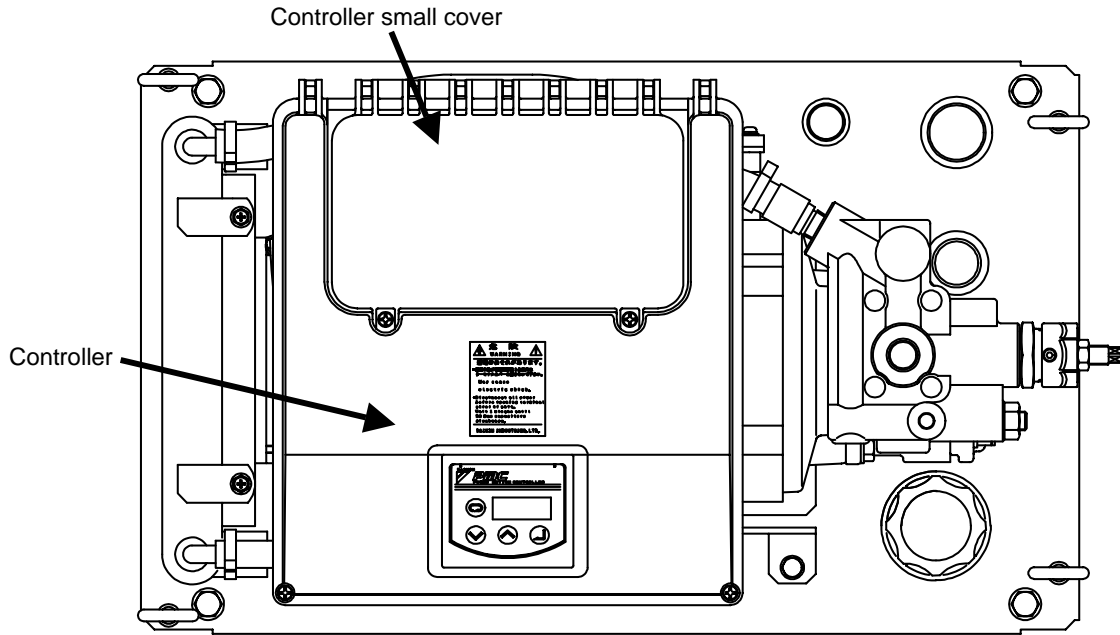

<Unit top view>

▲ DANGER

- In order to protect the electric circuit against short-circuiting and over-current and prevent electric shocks, the hydraulic unit main power supply must be equipped with a safety device (no-fuse breaker, earth leakage breaker, etc.) conforming to European Norm EN60947-2.
(For the power supply capacity, see the table below.)
- Use a power supply connection device with 3-phase contact distance of at least 3 mm in the switch-OFF status.
- For connection of the ground terminal, ensure at least Class D (former Class 3) grounding condition.
(Connect the ground terminal directly without using a breaker.)
- Be sure to complete installation of the hydraulic unit before wiring.
- Before wiring work, be sure to turn OFF the main power supply breaker, and make sure that the power is interrupted.
- Be sure not to connect the power supply cable to the I/O signal terminals.
- Do not apply an excessive power supply voltage higher than the specified power supply voltage to the hydraulic unit.

▲ CAUTION

- The hydraulic unit incorporates an overcurrent protection function. Therefore, it does not need an overcurrent protection thermal relay. If an overcurrent protection thermal relay is used, it may be affected by inverter switching, causing malfunction.

[Rated current and breaker setting]

Model	Power supply voltage and frequency			Breaker setting
	3φ 200V 50Hz	3φ 200V 60Hz	3φ 220V 60Hz	
EHU30R-M07	10.9A	10.7A	9.7A	15A
EHU15R-M07	7.9A	7.7A	7.1A	15A

◆ **Wiring procedure**

To connect the main power supply and I/O signal cables, remove the small cover of the controller.

<Remove the controller small cover by loosening the cross recessed round head machine screws (two M4 screws, Tightening torque: 0.6 N·m).>

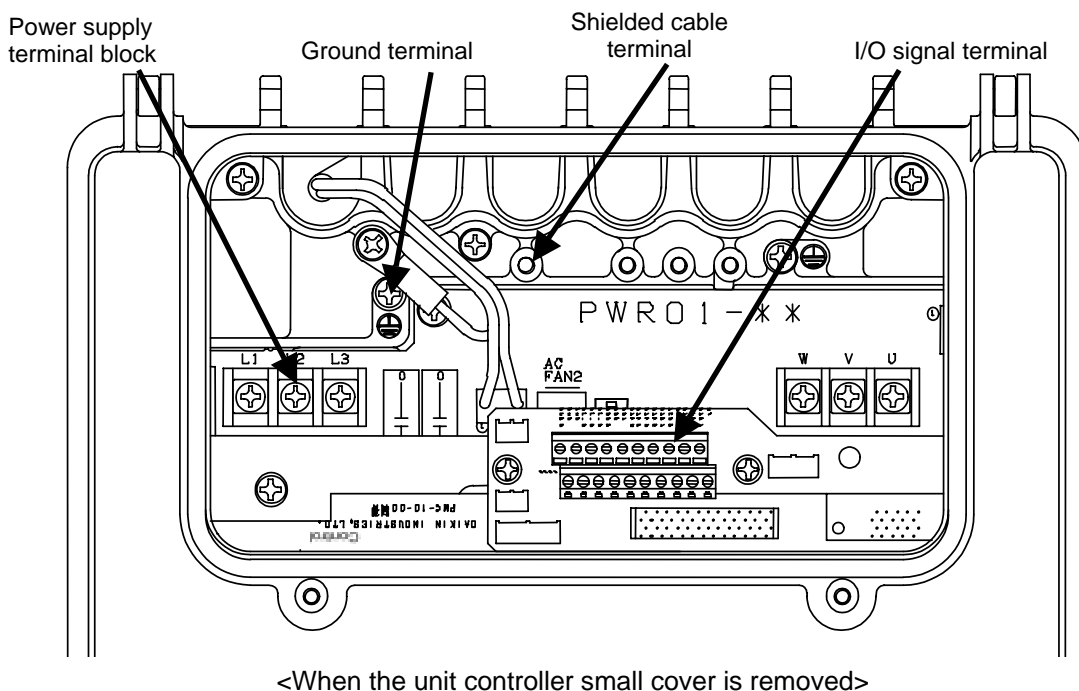
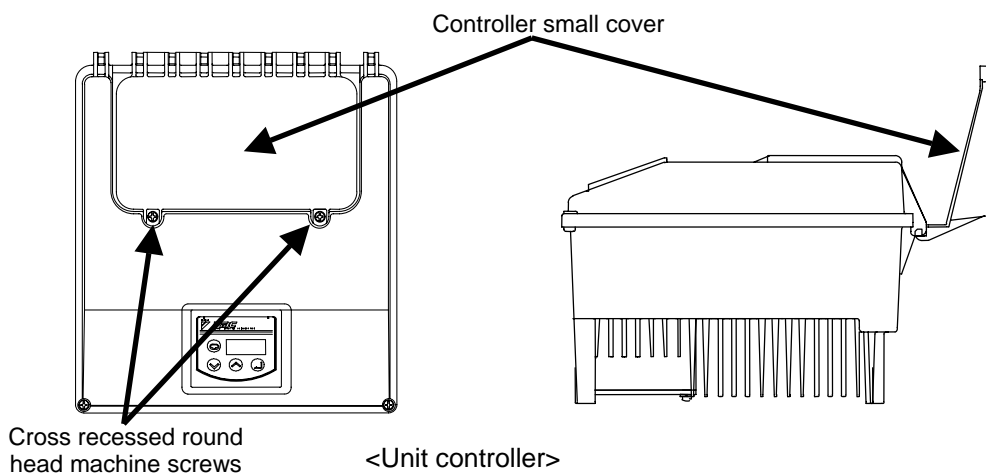

▲ DANGER

- [1] To access inside of the controller, follow the procedure described below.
 - i) Turn OFF the hydraulic unit main power supply. (Turn OFF the power supply circuit breaker.)
To prevent erroneous operation during wiring work, post an “Operation Prohibited (During Work)” sign on the power supply circuit breaker.
 - ii) Remove the controller cover after elapse of at least five minutes.
The controller uses a large-capacitance capacitor. If you connect cables with the capacitor charged, you may get electric shock. Before removing the controller cover, be sure to leave the controller for at least five minutes to discharge electricity from the capacitor.
- [2] Before turning ON the power supply to start operation, mount all controller covers.

▲ CAUTION

- The cross recessed round head machine screws in the controller small cover provide a drop-preventive structure. Do not attempt to remove them forcefully.

<How to use the cable clamp>

1. Loosen the tightening cap, and pass the cable through the clamp. Before this step, remove the controller fastening screw in advance.
2. Insert the cable into the controller through the controller's wiring hole.
3. Tighten the controller fastening screw to fasten the cable clamp to the controller.
4. Tighten the tightening cap to fasten the cable. The cable sheath protrusion length should be approx. 2 to 3 mm.

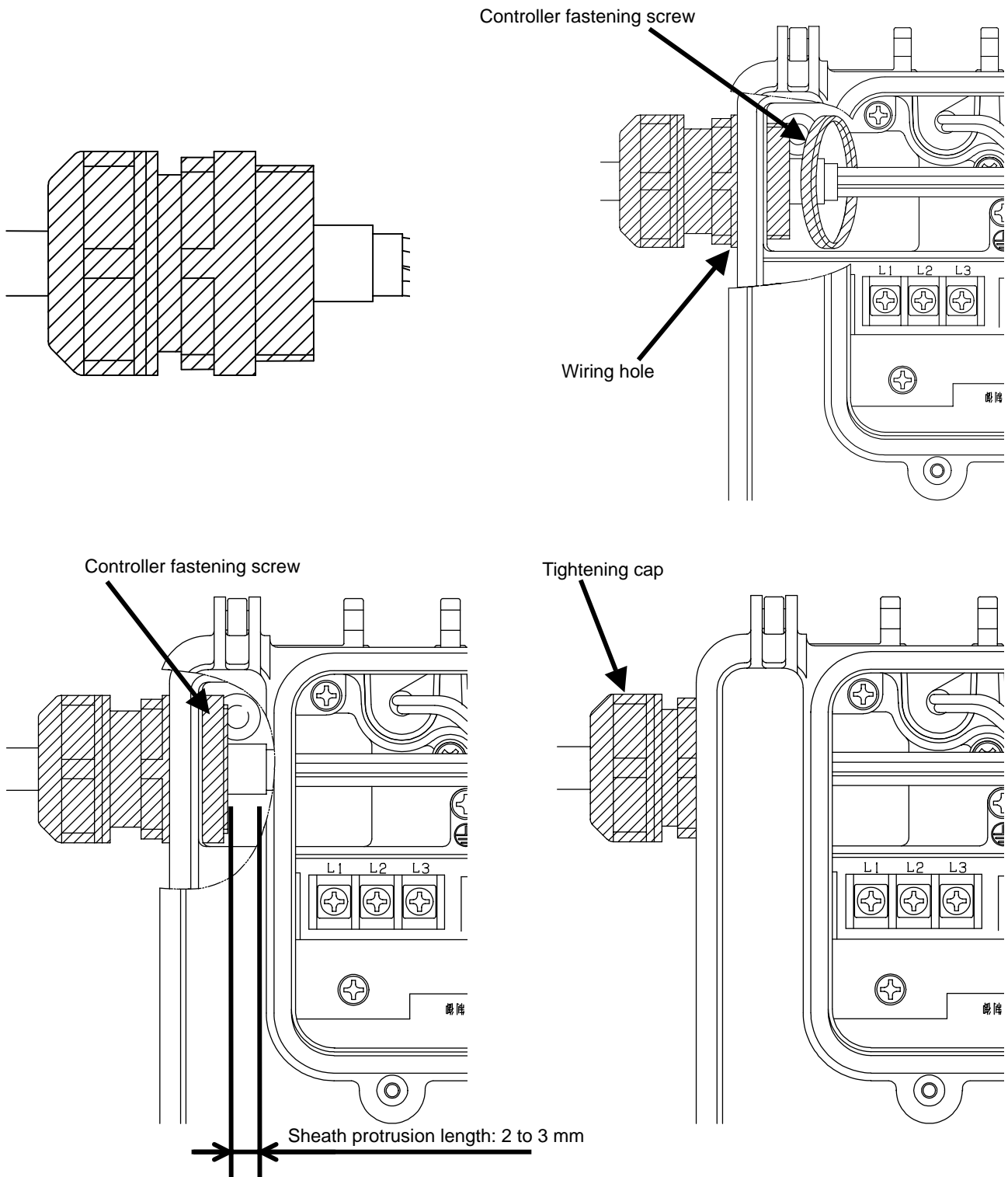

● **Connecting the main power supply cable**

- (1) Connect the main power supply cable to the controller through the controller's wiring hole. Use a cable clamp suitable for the wiring hole, whose protection rating should be **IP54 or higher level**. (Wiring hole diameter: 28 mm)
 - [1] Connect the ground cable to the controller's ground terminal.
 - [2] Connect the power supply cable to individual terminals on the power supply terminal block. (Tightening torque: 1.0 N·m)

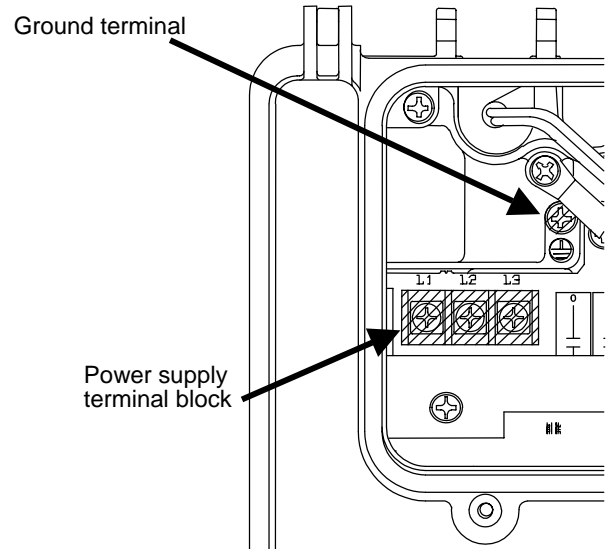
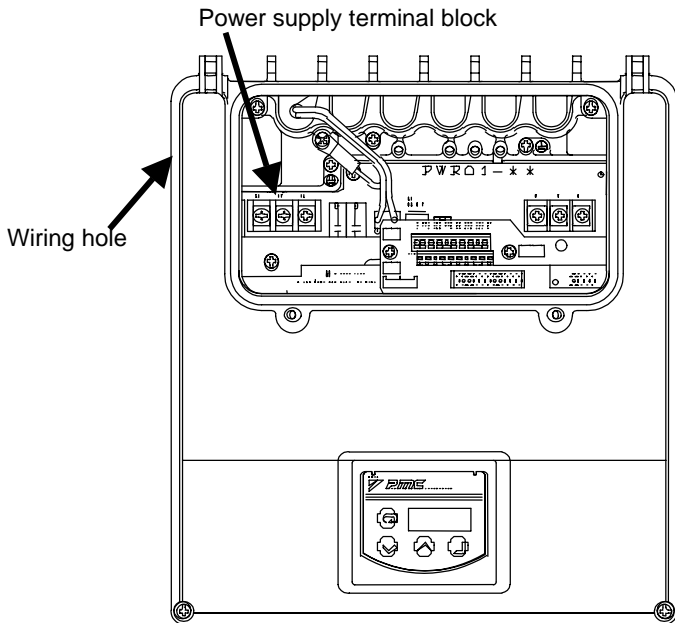

<When the unit controller small cover is removed>

<Enlarged view of power supply terminal block>

▲ DANGER

- Use an AC power supply conforming to the power supply specifications of this product.
- Use a power supply cable conforming to the power supply capacity. (See the table below.)
- Do not connect the power supply cable to the ground terminal.
- The ground terminal is connected with the motor frame.
Ensure at least Class D (former Class 3) grounding condition.
- When unsheathing the cable, be careful not to damage the conductors.
- Be careful that the cable conductors do not protrude from the terminal block.

▲ CAUTION

- For connection of the power supply cable, attach a crimp terminal to the tip of the cable.
- The cable inserted into the cable clamp should be a multi-core cable as those recommended below.
If two or more cables are inserted into the clamp, the cable clamp does not conform to the specified protection rating because of a gap between the cables and the cable clamp.
- When connecting the cable, be careful not to drop a screw into the housing.

Cable size	Recommended cable	Recommended crimp terminal	Recommended cable clamp
2.5 mm ² or more (AWG14 or larger size)	CE362 2.5 mm ² x 4 cores (manufactured by KURAMO)	TMEV-2-4 (manufactured by NICHIFU)	OA-W2216 (manufactured by OHM ELECTRIC) Applicable wire outer diameter: 11 to 16 mm

* For the power supply cable, use the 2451EC/H05RR-F cable.

<Power supply cable connecting procedure>

- [1] Unsheathe the cable by approx. 80 mm.

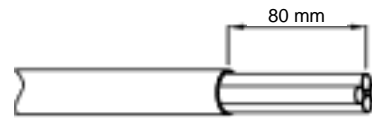

- [2] Remove the inner sheath so that the core wires are exposed by 8 to 10 mm.

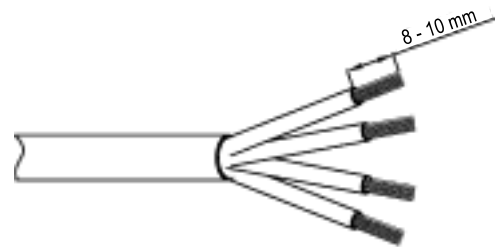

- [3] As shown on the right, crimp the round crimp terminal with insulation sheath by using a dedicated tool.

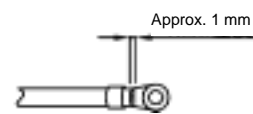

- [4] Connect each wire to the terminal block.

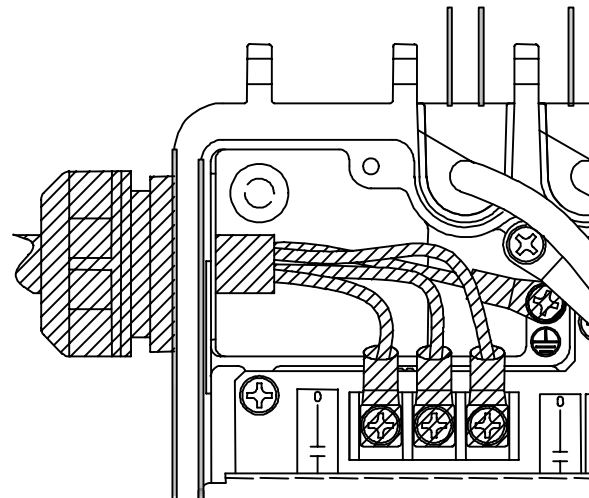
**▲ CAUTION**

- If the crimp tool is not suitable for the crimp terminal, the cable will come off the terminal due to a crimp failure during operation. This results in short-circuiting or burnout of the circuit caused by abnormal heating.

● Connecting the I/O signal cable

- (1) Pass the cable through a cable clamp, and connect it through the controller's wiring hole.
(Wiring hole diameter: 21 mm)
- (2) Check the specifications of individual signal lines (see p. 21), and connect the cable to the I/O signal terminal block.

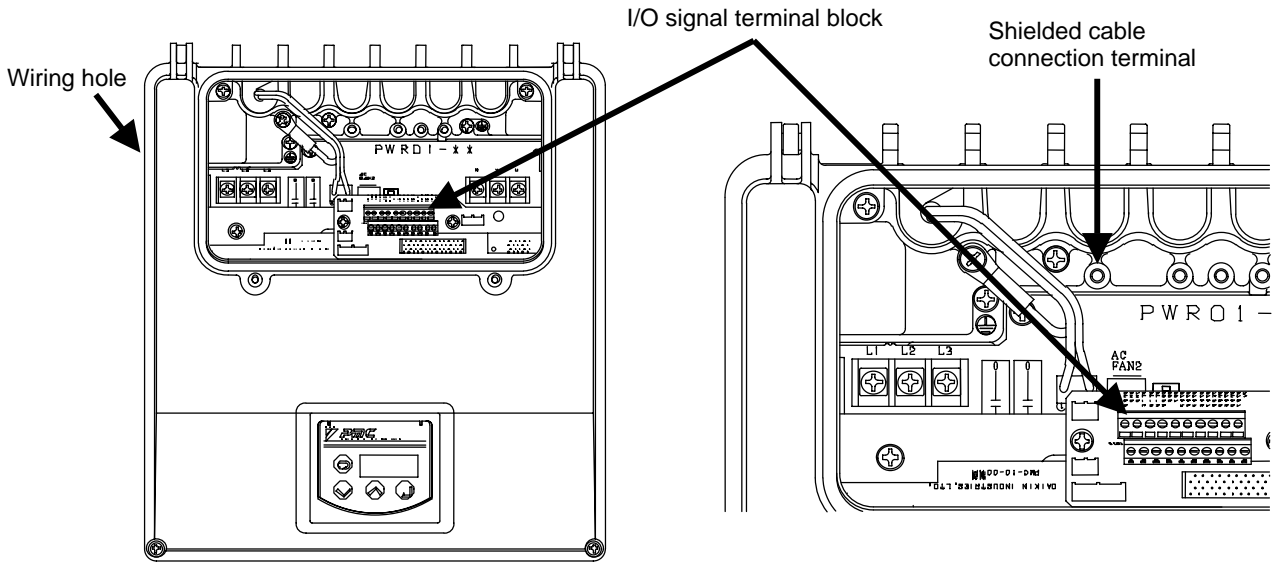

<When the unit controller small cover is removed>

<Enlarged view of I/O signal terminal block>

▲ DANGER

- Do not connect the I/O signal cable to the power supply terminal block.
- When unsheathing the cable, be careful not to damage the conductors.
- Be careful that the cable conductors do not protrude from the terminal block.

▲ CAUTION

- After checking the specifications of individual signal lines (see p. 21), connect the cable to the I/O signal terminal block.
- The cable inserted into the cable clamp should be a multi-core cable as those recommended below. If two or more cables are inserted into the clamp, the cable clamp does not conform to the specified protection rating because of a gap between the cables and the cable clamp.
- Terminate the shielded cable securely, and connect it to the shielded cable connection terminal.

Cable size	Recommended cable	Recommended cable clamp
0.5 to 0.3 mm ² (AWG20 to 22)	KCV-36SB 0.3 mm ² (manufactured by KURAMO)	OA-W1611 (manufactured by OHM ELECTRIC) Applicable wire outer diameter: 9 to 11 mm

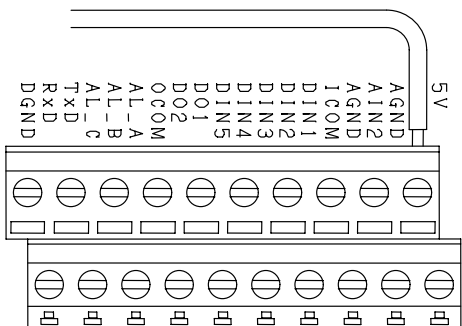

- [1] Loosen the screw with a screwdriver.
- [2] Check the unsheathed length of the cable, and insert it all the way into the terminal so that the conductors will not become loose.
- [3] Tighten the screw with a screwdriver.
- [4] Pull the cable lightly to make sure that it is securely connected.

Unsheathed length of the cable: 6 mm



Procedure for connecting the cable to the terminal block

■ I/O signal cable specifications

The following table lists specifications of the I/O signal terminals used for the interface between this controller and external equipment.

For details of each signal line, see the following pages.

Terminal No.	Type	Terminal name	Signal name	Remarks	
I/O signal terminal block	1	No connection		These terminals are not open to users. Do not use these terminals.	
	11				
	2				
	12				
	3				
	13	Digital input terminal	ICOM	Digital input common	Serves as both positive and negative common terminals.
	4		DIN1	Digital input 1	Controls start/stop operation. The operation at the time of signal input can be changed depending on the setting of the start/stop signal in the setting mode.
	14		DIN2	Digital input 2	PQ selection (0 to 3) can be changed depending on the combination of input signals.
	5		DIN3	Digital input 3	
	6	No connection			These terminals are not open to users. Do not use these terminals.
	15				
	16	Digital/contact output terminal	DO1	Digital output 1	See the table below. These terminals have been factory-set for total alarm output.
	7		DO2	Digital output 2	
	17		OCOM	Digital output common	
	8		AL_A	Contact output a	
	18		AL_B	Contact output b	
	9		AL_C	Contact output common	
	19	No connection			These terminals are not open to users. Do not use these terminals.
	10				
	20				

Terminal name	Total alarm output setting (P08 = 1)	Individual alarm output (P08 = 0)
D01	Completion signal output	
D02	No output	Output when an alarm or warning condition occurs.
OCOM	Negative common	
AL_A	Normally, connected with the common terminal.	Connected with the common terminal when the pressure switch is in normal condition.
AL_B	Connected with the common terminal when the pressure switch is activated or when an alarm or warning condition occurs.	Connected with the common terminal when the pressure switch is activated.
AL_C	Common	

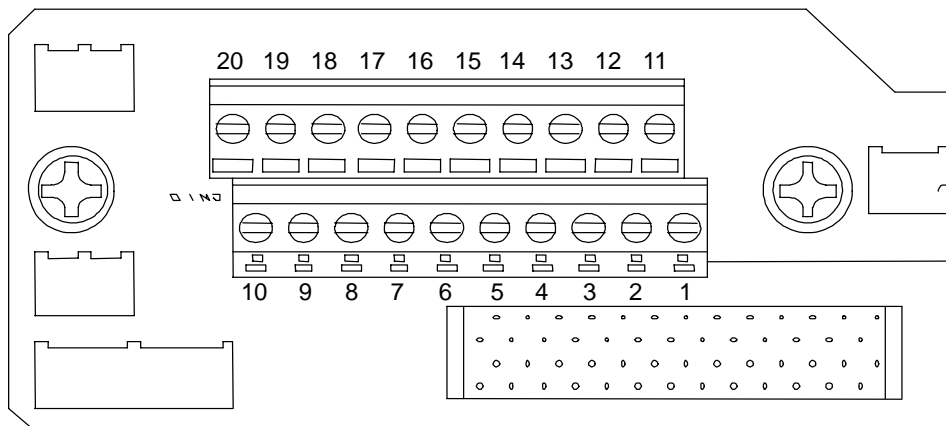

<Terminal block board in the controller>

◆ Digital input

These terminals are used for sequence input signals that control the unit operations from external equipment. Connect these terminals as required, with reference to the table below.

Terminal No.	Signal name	Remarks
13	Digital input common	Negative common
4	Digital input 1	Used for start/stop control. With the start/stop signal switching parameter (Setting mode: [P00]), you can change the operation at signal input. (See p. 31)
14	Digital input 2	P-Q selection Nos. 0 to 3 can be selected depending on the combination of digital input status. (For P-Q selection setting, see p. 31.)
5	Digital input 3	

Note) While the unit is stopped by digital input, the panel shows “STP”.

Combination of digital inputs for P-Q selection

P-Q selection No.	Digital input 2 PQ0	Digital input 3 PQ1
0	OFF	OFF
1	ON	OFF
2	OFF	ON
3	ON	ON

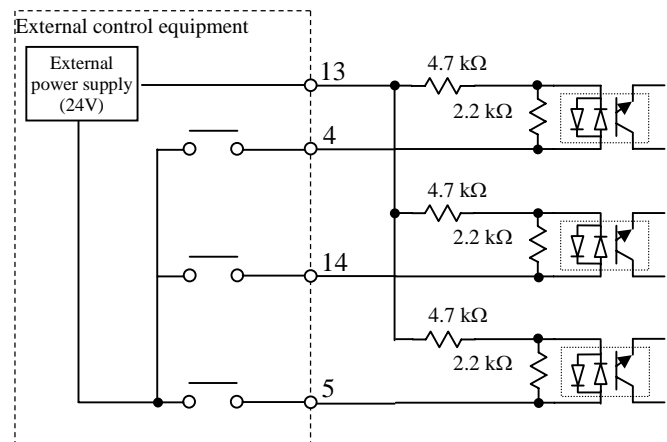

▲ CAUTION

- For the external power supply, use a power supply with **24 VDC ± 1V, 0.5 A or higher capacity**.
- Power cannot be supplied from this controller to external equipment.
- The current flowing through each input circuit is **5 mA (typical)**. To configure a circuit with a contact, be careful about the minimum current of the contact.

◆ Digital output/Contact output

These terminals are used for digital/contact output signals that output alarm status of this unit. Connect these terminals as required, with reference to the table below. For description on the outputs, see the alarm codes on p. 33.

Terminal No.	Signal name	Remarks
16	Digital output 1	Complete signal (See the timing chart in the Attachment.)
7	Digital output 2	No output
17	Digital output common	Negative common

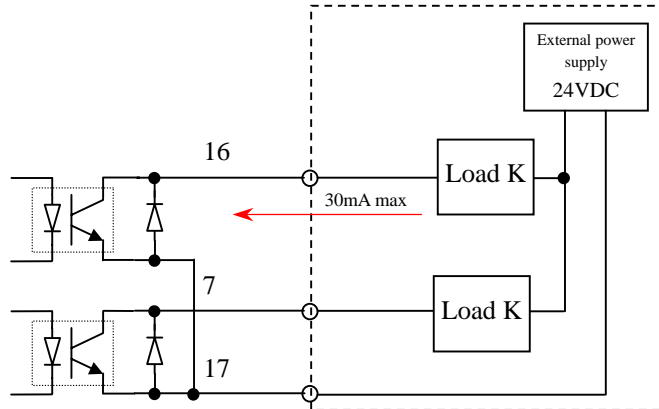

▲ CAUTION

- As the external power supply, prepare a 24 VDC ± 1V, 0.5 A power supply. Power cannot be supplied from this controller to external equipment.
- This controller’s output circuit serves as negative common.
- The maximum output current of an output circuit is 30 mA (resistance load). If you attempt to drive load higher than the allowable current, the circuit may be damaged. Pay attention to the maximum allowable current.
- To drive induction load, take surge preventive measures.

Terminal No.	Signal name	Remarks
8	Contact output a	Normally, connected with the common terminal.
18	Contact output b	Connected with the common terminal when the pressure switch is activated or when an alarm or warning condition occurs.
9	Contact output common	Common

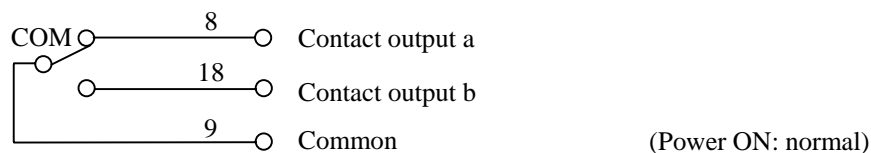

▲ CAUTION

- The contact output switching capacity is **30 VDC/0.5 A (resistance load)**. If you attempt to drive load higher than the allowable current, **the contact may be damaged**. Pay attention to the maximum allowable current.
- The minimum allowable load of the contact output is **10 mVDC/10 μA**. However, it is an approximate lower limit that enables the contact to be opened/closed under minute load. This value varies depending on switching frequency and environmental conditions. We recommend you to check the minimum allowable load in actual conditions.
- To drive induction load, take surge preventive measures.

[10. Test Run]

Supply hydraulic oil into the tank to the specified level, and conduct a test run after piping and electric wiring are completed.

(Before turning ON the power supply, re-check if the ground cable and power supply cable are securely connected.)

◆ Start check

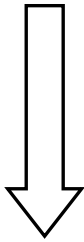

◆ Flushing

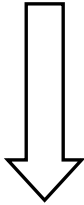

◆ Oil replacement

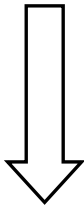

◆ Air vent

- Turn ON the switch on the machine control panel.
 - [1] Check the pump operation sound, and confirm that a pressure indicated on the display panel increases.
 - [2] Confirm that the oil cooler AC fan is running.

NOTE) This hydraulic unit takes a warm-up time of approx. three seconds until it starts operation after power-ON.

(The pressure rising time varies depending on the pipe volume.)

Furthermore, the hydraulic unit takes a time to increase the circuit pressure above the set pressure of the pressure switch. During this period, the pressure switch signal may be output depending on the pipe condition (pipe volume). In such a case, set up the master machine so that it does not receive the alarm output.

- After completion of the start check, connect all piping (except for the actuator piping) in a loop, and run hydraulic oil through the filter to perform flushing operation for approx. two hours.
- Before flushing operation, check all pipe connections for looseness and oil leak.

- After completion of the flushing operation, check the filter for clogging. If the filter is clogged, replace the filter, and drain all hydraulic oil from tank through the oil drain port.
- Fill new hydraulic oil through the oil filling port (air breather) to the specified level.
(Use new clean hydraulic oil with pollution degree of NAS Class 9 or lower level.)

- Evacuate air from the hydraulic circuit completely. If air is not completely evacuated, the following phenomena may occur.
 - [1] Abnormal operation of cylinder actuator
 - [2] Abnormal sound of pump and valve





▲ DANGER

- When evacuating air, high-pressure and high-temperature oil may spout out. Pay attention to oil splash.

[11. Operation Panel Operating Procedure]

This hydraulic unit enables you to monitor or change pressure, flow rate or other parameter settings by operating the controller key switches.

■ Outline of functions

The operation panel is comprised of the 3-digit LED **8.8.8**, mode key , setting keys   and ENT key . Normally, the panel shows an actual pressure value. It can be switched between the monitor display mode and set value display mode through key operations.

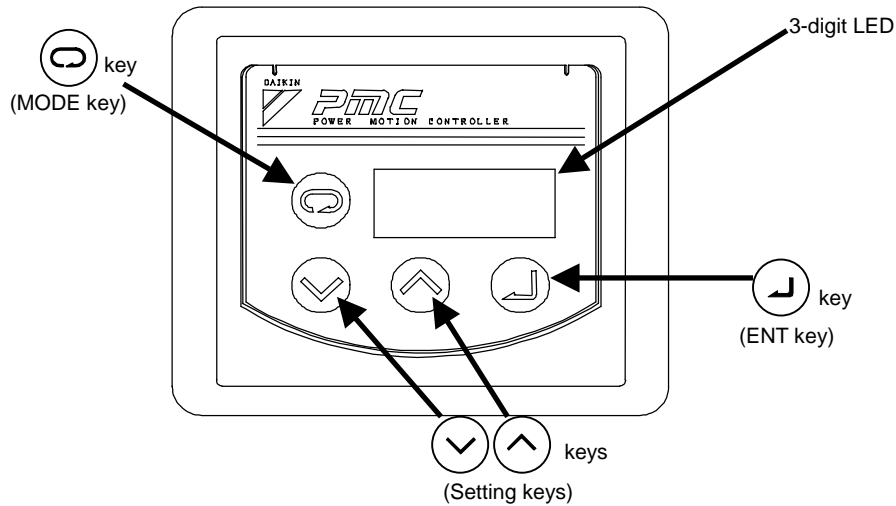

■ Description on individual modes

- Normal mode: Displays an actual pressure value or alarm code.
- Monitor mode: Displays a pressure switch set value, pressure set value, flow rate set value, actual flow rate, and actual rpm.
- Setting mode: Used to set or change a parameter such as pressure and flow rate.
- Alarm mode: Alarm records can be checked.

■ Shift between individual modes

Key switch operations for shift between individual modes are shown below:

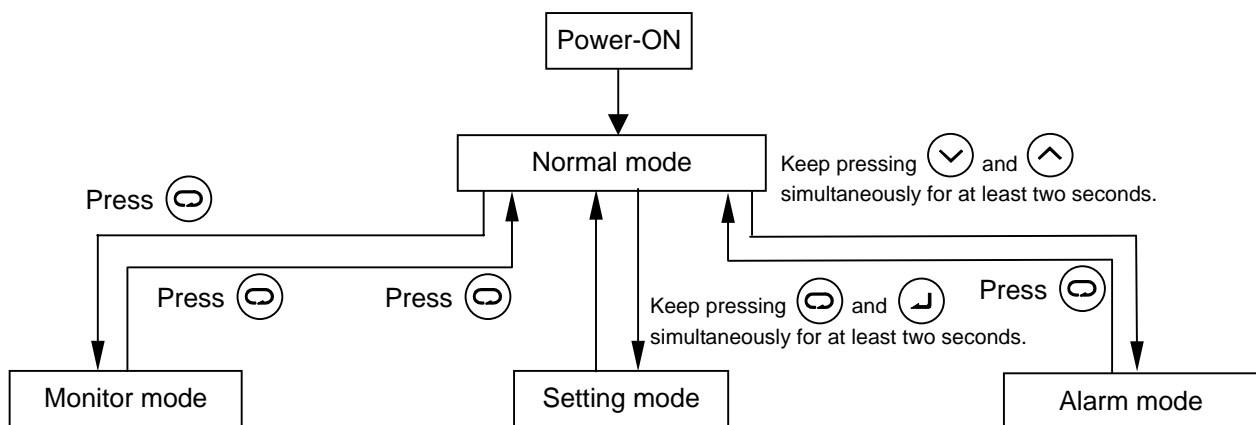

■ Operating procedure for each mode

a) Monitor mode

The monitor mode allows you to monitor a parameter by selecting a desired item from the following table.

Parameter No.	Name	Description
n00	Pressure switch setting	(MPa) [When PSI unit is selected, x 10PSI] Displays a pressure switch setting.
Note 1) n01	Pressure setting	(MPa) [When PSI unit is selected, x 10PSI] Displays a pressure setting for the current P-Q selection No.
n02	Discharge rate setting	(L/min) Displays a flow rate setting for the current P-Q selection No.
n03	Discharge rate	(L/min) Displays the current discharge rate.
Note 2) n04	Latest alarm code	Displays the latest alarm code.
n05	rpm	(min ⁻¹) Displays the current rpm.
n06	Operating status	Displays the current P-Q selection No.
n07	Reverse rpm at power-OFF	Displays a motor reverse rpm due to counter-flow from the load when the unit power supply is turned OFF. This parameter is used to estimate the machine load volume.
n08	Regenerative load integration ratio	Displays the load integration ratio of the current regenerative braking resistance.

Note1) With the factory setting, “MPa” is the standard unit. When it is changed to the PSI unit, attach **a label to indicate the PSI display mode**.







However, if the PSI unit is used in Japan, you will be punished under the Measuring and Weighing Law. The indication label should be prepared by the user.

Note 2) For details on the alarm codes, refer to description on the alarm display mode.

You can check **the current power-ON count** by pressing the  key when an alarm code is displayed.

An example of monitor mode operation is shown below.

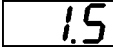
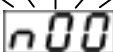
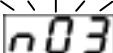
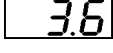
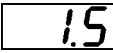
<Example> Monitoring current discharge rate

Operating procedure	Key operation	3-digit LED	Remarks
<ul style="list-style-type: none"> • Power-ON ↓ (Startup, Run) • Actual pressure display • Shift to monitor mode ↓ • Parameter No. selection ↓ • Monitor display ↓ • Return to actual pressure display mode 	   	    	<p>Press the  key three times. Blinking</p> <p>Discharge rate (theoretical value) 3.6 L/min</p>

To monitor other parameter, return to the actual pressure display mode once, and then select a desired item.

b) Setting mode

The setting mode allows you to set or change a parameter such as pressure and flow rate on the operation panel. For the parameters that can be specified or changed in the setting mode and their adjusting ranges, see the list of setting ranges on p. 31.

For the initial values and adjusting ranges of non-standard models or custom-made models, see **the delivery specifications** on separate sheets.

NOTE:

[1] The above discharge rate set value is a theoretical value (the product of theoretical displacement volume by rpm). It is slightly different from the actual discharge rate.

The setting mode allows you to set (adjust) a parameter by selecting a desired item from the following table.

Parameter No.	Name	Description
P00	Start/stop signal switching	Specify whether to run or stop the unit at signal input.
P01	Pressure switch setting	Specify whether to enable or disable the pressure switch function, and the pressure to activate the pressure switch.
P02	Pressure alarm output delay time setting	Specify the delay time until alarm output after the pressure falls below the pressure switch activating pressure.
P03	Pressure switch display hold setting	Specify the function that indicates that the pressure switch is activated. For details on this function, see “Alarm code and classification table” on p. 33.
P04	Pressure unit selection setting	Used to change the unit of the normal pressure display mode (“MPa” or “x10 PSI”).
P05	Regenerative load command ratio setting	Adjust the regenerative load when it is too much increased at normal pressure response (FF → DH).
P06	AC fan motor synchronization setting	Specify whether to start or stop the radiator AC fan in synchronization with start/stop signal input.
P07	Warning output level setting	Specify a warning output level.
P08	Alarm output combination setting	Specify whether to activate the contact outputs (alarm, warning and pressure switch outputs) individually, or integrate them into one output. (See the timing chart in Attachment on p. 44.)
P09	Reset to factory setting	Resets current settings to the factory-set conditions.
P10	Response gain	Adjust a control response value. (A smaller value makes quicker response.)
P11	Acceleration response gain	Adjust an acceleration response value. (A larger setting makes quicker acceleration response. However, it easily causes vibration during deceleration.)
P12	Solenoid valve response delay time	Specify a solenoid valve response delay time so that a P-Q selection is synchronized with motion of the operating axis.
P13	P-Q selection 0 to 3 Pressure, flow rate, acceleration time and deceleration time settings	This mode is used to set a pressure, flow rate, acceleration time and deceleration time for each P-Q selection No. Set the following items in this order: P <Pressure setting> q <Flow rate setting> U <Acceleration time setting> d <Deceleration time setting>
P14		
P15		
P16		

Normally, the P05, P10 and P11 settings need not to be changed. However, if a special circuit condition (large load volume, etc.) is expected, these settings must be changed.

• Flow rate setting changing procedure

An example of flow rate setting changing operation is shown below.

<Example> Changing flow rate for P-Q selection 1 from 28.5 L/min to 22.8 L/min.

Operating procedure	Key operation	3-digit LED	Remarks
• Power-ON			
• Actual pressure display			
• Setting mode			
	Keep pressing two keys simultaneously for at least two seconds.		After two seconds
• Parameter No. selection	or		
			P-Q selection 1
• Set value display			Displays pressure set value for P-Q selection 1
• P-Q selection	Press .		Displays flow rate set value for P-Q selection 1
	"P.01", "q.01", "U.01" and "d.01" are alternately displayed in this order.		
• Changing set value	or		
• Writing set value			Displays an acceleration time set value after writing a flow rate set value.
• Return to actual pressure display mode			











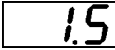

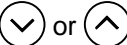
CAUTION: The flow rate setting can be arbitrarily specified in steps of 0.1 L/min.

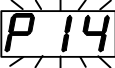
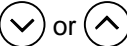
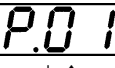
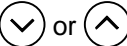
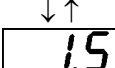
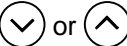
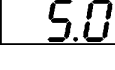
Model	Theoretical pump displacement volume (cc/rev)
EHU30R-M07	5.7
EHU15R-M07	4.0

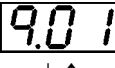
• Pressure setting changing procedure

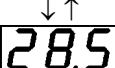
An example of pressure setting changing operation is shown below.

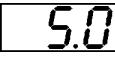
<Example> Changing pressure for P-Q selection 1 from 1.5 MPa to 5.0 MPa

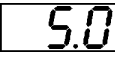
Operating procedure	Key operation	3-digit LED	Remarks
<ul style="list-style-type: none"> • Power-ON 			
<ul style="list-style-type: none"> • Actual pressure display (When "P-Q selection 1" is selected) 			
<ul style="list-style-type: none"> • Setting mode 			
<ul style="list-style-type: none"> • Parameter No. selection 	<p>Keep pressing two keys simultaneously for at least two seconds.</p> 		<p>After two seconds</p>
<ul style="list-style-type: none"> • Set value display 			<p>P-Q selection 1</p>
<ul style="list-style-type: none"> • Changing set value 			<p>Displays pressure set value for P-Q selection 1</p>
<ul style="list-style-type: none"> • Writing set value 			
<ul style="list-style-type: none"> • Changing set value 			
<ul style="list-style-type: none"> • Writing set value 			<p>Displays a flow rate set value after writing a pressure set value.</p>
<ul style="list-style-type: none"> • Changing set value 			
<ul style="list-style-type: none"> • Writing set value 			
<ul style="list-style-type: none"> • Return to actual pressure display mode (When "P-Q selection 1" is selected) 			

• Setting range

Parameter No.	Description	Initial setting		Operating range ^{Note 1}		Display unit	
		EHU30R -M07	EHU15R -M07	EHU30R -M07	EHU15R -M07		
P00	Start/stop signal switching	1		0: Run at signal input 1: Stop at signal input		-	
P01	Pressure switch setting	0		0 to 35.0 (0: Disabled)		(MPa)	
				0 to 507 (0: Disabled)		[When PSI unit is selected, × 10PSI]	
P02	Pressure switch output delay time setting	0		0.00 to 9.99 (9.99 sec. max.)		(sec)	
P03	Pressure switch display hold setting	0		0: Disabled 1: Holds display during pressure switch activation 2: Display and memory during pressure switch activation		-	
P04	Pressure unit selection setting	0		0: MPa 1: PSI		-	
P05	Regenerative load command ratio setting	50		30 to 100		(%)	
P06	AC fan motor synchronization setting	0		0: Continuous operation 1: Synchronous operation		-	
P07	Warning output level setting	0		0: No warning output 1: Warning status output 2: Alarm equivalent output		-	
P08	Alarm output combination setting	1		0: Individual alarm output 1: Integrated alarm output See Attachment. ^{Note 6}		-	
P09	Reset to factory setting	0		0: Retains current settings 1: Reset to factory settings ^{Note 7} 2: Reset all to factory settings		-	
P10	Response gain ^{Note 2}	20	25	5 to 999 (A smaller value makes quicker response.)		-	
P11	Acceleration response gain ^{Note 2}	200		0 to 500		-	
P12	Solenoid valve response delay time	0		0.00 to 9.99		(sec)	
P13 to P16	P-Q selection 0 to 3 Pressure, flow rate, acceleration time and deceleration time settings						
	P.00 to P.03: Pressure setting ^{Note 3}		0.5		0.5 to 7.0		(MPa)
	q.00 to q.03: Flow rate setting ^{Note 4}		28.5	15.2	3.4 to 28.5	3.4 to 15.2	(L/min)
	U.00 to U.03: Acceleration time setting ^{Note 5}		0.10		0.01 to 9.99		(sec/MPa) (sec/1000min ⁻¹)
	d. 00 to d.03: Deceleration time setting ^{Note 5}		0.10		0.01 to 9.99		(sec/MPa) (sec/1000min ⁻¹)

Note 1 For setting or adjustment on the operation panel, a value exceeding the above operating range can be specified. However, be sure to use the unit within the specified operating range.

Note 2 If the load volume is normal, response gain adjustment is not required. If the response gain is changed to an improper value, the unit operation becomes unstable, or surge pressure may be generated.

Note 3 Make sure that the pressure setting is lower than “Safety valve set value - 0.5 MPa”.

Note 4 The flow rate setting can be arbitrarily specified in steps of 0.1 L/min.

Note 5 Setting acceleration time simultaneously defines both pressure increase (pressure) and speed increase (flow rate).
Setting deceleration time simultaneously defines both pressure decrease (pressure) and speed reduction (flow rate).

Note 6 Specify whether to activate the contact outputs (alarm, warning and pressure switch outputs) individually, or integrate them into one output.

Note 7 Selecting “1: Reset to factory settings” resets the P00 to P08 parameters to the factory settings.
Selecting “2: Reset all to factory settings” initializes all parameters and resets them to the factory settings.
To recall the factory settings, turn off the power supply once and turn it on again, after selecting “1: Reset to factory settings” or “2: Reset all to factory settings”.









c) Alarm mode

The alarm mode allows you to check alarm conditions listed below by selecting any item between A00 and A09.

Alarm No.	Description	Remarks
A00 to A09	Alarm code indicating alarm condition (For each code, see the attached table.)	A smaller No. indicates a later alarm.

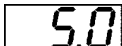
An example of alarm mode operation is shown below.

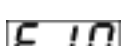
<Example> Checking an alarm condition (E10: IPM alarm) of an alarm before the latest one (A01)

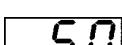
Operating procedure	Key operation	3-digit LED	Remarks
<ul style="list-style-type: none"> • Power-ON ↓ • Actual pressure display • Alarm mode ↓ • Selecting alarm No. ↓ • Displays alarm condition ↓ • Return to actual pressure display mode 	<p style="text-align: center;">  Keep pressing two keys simultaneously for at least two seconds. Press  once. </p> <p style="text-align: center;">   </p>	<p style="text-align: center;">   After two seconds (Displays the latest alarm)  Displays an alarm before the latest one  ↓ ↑   </p>	<p>After two seconds</p> <p>Alarm code and power-ON count are alternately displayed at a second interval.</p>

■ Alarm code display list

The hydraulic unit incorporates alarm detecting functions that are classified as follows:

◆ Panel display, unit operation and external output signal at occurrence of trouble

Unit status	Error condition	Panel display	Unit operation	External output signal
Normal operation	[1]	Alarm No. display	Operation stop	See the table on the next page.
Power-ON (during initialization)	[2]	Alarm No. and erroneous parameter No. are alternately displayed.		
Normal operation	[3]	Warning No. and actual pressure value are alternately displayed.	Operation continued	
Normal operation	[4]	Warning No. display		

◆ Alarm codes and classification table

(Individual alarm output: When the alarm output combination setting [P08] is “0”)
(Integrated alarm output: When the alarm output combination setting [P08] is “1”)

Classification	Description	Panel indication	External output status				
			○: There is continuity in the circuit. ×: There is no continuity in the circuit. –: The status immediately before alarm activation is retained.				
			Individual alarm output		Integrated alarm output		
			Relay output		Alarm/ Warning	Relay output	
A contact	B contact		A contact	B contact			
	Power OFF	–	×	○	×	×	○
	Power ON: Normal	Actual pressure display	○	×	○	○	×
[1]	Output device error	E10	–	–	×	×	○
	Instantaneous overcurrent	E11	–	–	×	×	○
	Overspeed	E12	–	–	×	×	○
	Regenerative brake overload	E14	–	–	×	×	○
	Undervoltage	E15	–	–	×	×	○
	Overvoltage	E16	–	–	×	×	○
	Electronic thermal	E17	–	–	×	×	○
	Magnetic pole detection error	E18	–	–	×	×	○
	Encoder cable break	E20	–	–	×	×	○
	Motor cable break	E21	–	–	×	×	○
	Power supply open phase	E24	–	–	×	×	○
	Pressure sensor error	E30	–	–	×	×	○
	Motor start error	E31	–	–	×	×	○
	Motor thermistor cable break	E40	–	–	×	×	○
	Motor temperature abnormal rise	E41	–	–	×	×	○
	Radiator fin thermistor cable break	E42	–	–	×	×	○
	Fin temperature abnormal rise	E43	–	–	×	×	○
Drying operation error	E64	–	–	×	×	○	
CPU runaway (watchdog)	E91	–	–	×	×	○	
[2]	EEPROM data error (1)	E93	×	○	×	×	○
	EEPROM data error (2)	E94	×	○	×	×	○
[3]	Motor temperature abnormal warning	L44	○	×	×	×	○
	Fin temperature abnormal warning	L45	○	×	×	×	○
	Power supply voltage drop warning	L50	○	×	×	×	○
	Pressure deviation abnormal warning	L60	○	×	×	×	○
[4]	Pressure switch activation ^{Note 1}	L63	×	○	○	×	○

During activation of an alarm of Classification [1], the system records the alarm, and holds the alarm code on the display. During activation of an alarm of Classification [1], the pressure switch does not work. The system retains the status immediately before activation of the alarm.

When alarm output combination setting [P08] is “1” (integrated alarm output is selected), the alarm signal is output even if the warning/pressure switch is activated.

Note 1 The pressure switch activation alarm code (“L63” of Classification [4]) is displayed only with the a) or b) setting below:

a) When the pressure switch display hold setting (Setting mode [P03]) is “1” or “2”.

b) When the pressure switch setting [P01] is enabled (When any number other than “0” is entered)

When the pressure switch display hold setting [P03] is “1” or “2”, the display hold status cannot be reset until the  key is pressed.

When the pressure switch display hold setting [P03] is “2”, the alarm is stored in the alarm record if the pressure falls below the value of the pressure switch setting [P01].

* The alarm/warning output of the individual alarm output of Classification [3], and the relay output B contact of the integrated alarm output vary depending on the warning output level setting [P07].

See “Attachment: Power-ON External I/O Signal Timing Chart”.

◆ Causes of alarms and corrective actions

Classification	Alarm	Indication	Cause of output	Corrective action
[1]	Output device error	E10	Power device's self-protective function is activated.	If the alarm condition persists even after the power supply is turned OFF and ON, consult the following DAIKIN Contact Center.
	Instantaneous overcurrent	E11	An instantaneous overcurrent was detected in the current control unit.	If the alarm condition persists even after the power supply is turned OFF and ON, consult the following DAIKIN Contact Center.
	Overspeed	E12	The motor rotation speed exceeded the allowable speed. (Including reverse rotation)	Check for a problem in the hydraulic circuit. If the alarm condition persists, consult the following DAIKIN Contact Center.
	Regenerative brake overload	E14	Output when regenerative overload occurs due to motor's regenerative current.	Check the total regenerative load ratio in the monitor mode [n08], and reduce the load in the process where the total load ratio has increased.
	Undervoltage	E15	The main circuit voltage has dropped to 190 VDC (134 VAC) or less.	Check the power supply voltage. If the alarm condition persists, consult the following DAIKIN Contact Center.
	Overvoltage	E16	The main circuit voltage has increased to 400 VDC or more.	Check the power supply voltage. If the alarm condition persists, consult the following DAIKIN Contact Center.
	Electronic thermal	E17	Overload was detected in current output status. (60 seconds at 110%)	The motor output is higher than the normal level. If the alarm condition persists, consult the following DAIKIN Contact Center.
	Magnetic pole detection error	E18	Motor initial position detection error	If the alarm condition persists, consult the following DAIKIN Contact Center.
	Encoder cable break	E20	Output when the encoder cable has broken.	The encoder cable replacement may be required. Consult the following DAIKIN Contact Center.
	Motor cable break	E21	Output when the motor cable has broken.	If the alarm condition persists, consult the following DAIKIN Contact Center.
	Power supply open phase	E24	Output when power supply open phase was detected.	If the alarm condition persists, consult the following DAIKIN Contact Center.
	Pressure sensor error	E30	Output when the pressure sensor feedback value is abnormal.	If the alarm condition persists, consult the following DAIKIN Contact Center.
	Motor start error	E31	Output when the actual rotation polarity is different from the polarity specified in the command.	If the alarm condition persists, consult the following DAIKIN Contact Center.
	Motor thermistor cable break	E40	Output when the motor thermistor cable has broken.	The thermistor cable replacement may be required. Consult the following DAIKIN Contact Center.
	Motor temperature abnormal rise	E41	Forcefully stops when the motor temperature reaches a specified temperature in the L44 status.	The motor's heat radiation and cooling capacities may be deteriorated. Conduct maintenance of the motor.
	Radiator fin thermistor cable break	E42	Output when the fin thermistor cable has broken.	The fin thermistor cable replacement may be required. Consult the following DAIKIN Contact Center.
	Fin temperature abnormal rise	E43	Forcefully stops when the fin temperature reaches a specified temperature in the L45 status.	The controller's heat radiation and cooling capacities may be deteriorated. Conduct maintenance of the controller.
	Drying operation error	E64	Output when the pressure does not increase even if the rotation speed is increased.	The oil level in the tank may be decreased. Refill hydraulic oil into the tank.
CPU runaway (watchdog)	E91	Output when the CPU becomes out of control.	If the alarm condition persists, consult the following DAIKIN Contact Center.	
[2]	EEPROM data error (1)	E93	Output when EEPROM data are abnormal.	If the alarm condition persists, consult the following DAIKIN Contact Center.
	EEPROM data error (2)	E94	Output when EEPROM data are abnormal.	If the alarm condition persists, consult the following DAIKIN Contact Center.

Classification	Alarm	Indication	Cause of output	Corrective action
[3]	Motor temperature abnormal warning	L44	Output when the motor thermistor temperature exceeded the threshold level.	The motor's heat radiation and cooling capacities may be deteriorated. Conduct maintenance of the motor.
	Fin temperature abnormal warning	L45	Output when the fin thermistor temperature exceeded the threshold level.	The controller's heat radiation and cooling capacities may be deteriorated. Conduct maintenance of the controller.
	Power supply voltage drop warning	L50	Output when the power supply voltage is 180 V or less.	Check the power supply voltage. If the alarm condition persists, consult the following DAIKIN Contact Center.
	Pressure deviation abnormal warning	L60	Output when the command signal is saturated for at least 5 seconds.	The motor output is higher than the normal level. If the alarm condition persists, consult the following DAIKIN Contact Center.
[4]	Pressure switch activation	L63	Indicated when the pressure switch is activated. (Selectable with the parameter)	

DAIKIN Contact Center - Total Customer Service

0120 - 14 - 9955 (Nationwide common free-call No.)

(To ensure smooth call-back, please dial "186" first.)

<Operating hours: 24 hours throughout the year>

Send fax inquiry to: 0120 - 84 - 1069 (Free Fax No.)

West Japan Contact Center

4-5-2 Koraibashi, Chuo-ku, Osaka, 541-0043 Japan

[12. Maintenance]

To keep the motor pump performance in good conditions for a long period, conduct periodic maintenance on the following items. If there is a problem, repair or replace defective parts.

Standard inspection cycles are listed below. However, these cycles considerably vary depending on the operating conditions and environment.

■ Periodic inspection

Item	Inspection cycle	Method
<ul style="list-style-type: none"> ● Oil tank <ul style="list-style-type: none"> • Oil level check • Oil temperature check • Oil color check 	Daily, Occasionally Daily, Occasionally Semiannually	Make sure that the float of the oil level gauge is between the red and yellow lines. Check the hydraulic oil for whitish muddiness and air bubbles. Make sure that the oil temperature is 60°C or less. (Normally, use the oil at 15 to 50°C.) Deterioration of hydraulic oil can be checked by color. If the hydraulic oil turns brownish (ASTM L4 level: bright yellow), replace it.
<ul style="list-style-type: none"> ● Oil cooler <ul style="list-style-type: none"> • AC fan rotation • Clogging of the core 	Daily, Occasionally Semiannually	Check if the AC fan is rotating. Visually check the core for clogging. If the AC fan rotation is stopped, or the core is clogged, <ol style="list-style-type: none"> [1] the oil cooler cooling capacity remarkably deteriorates. This causes the hydraulic oil or the unit to become hot, resulting in burns. Also, this accelerates deterioration of the hydraulic oil, causing the unit service life to be shortened. [2] the motor becomes hot, causing the motor service life to be shortened. [3] the controller heat radiation performance deteriorates, causing the electric component service life to be shortened. The AC fan serves to cool the motor and controller, as well as to cool hydraulic oil.
<ul style="list-style-type: none"> ● Pressure display <ul style="list-style-type: none"> • Operation check • Pressure display check 	Daily, Occasionally Daily, Occasionally	Check if the indicated value changes according to load condition changes. Make sure that the pressure display for D.H. conforms to the preset value.
<ul style="list-style-type: none"> ● Sound and vibration 	Daily, Occasionally	Check for abnormal sound and vibration.
<ul style="list-style-type: none"> ● Electric wiring 	Semiannually	<ol style="list-style-type: none"> [1] Check the cable sheathing for cracks or fracture. [2] Measure the insulation resistance, and check for a decrease in insulation resistance. [3] Make sure that the ground cable is securely connected.
<ul style="list-style-type: none"> ● Hose 	Yearly	Check the hose for cracks, fracture or flaws.
<ul style="list-style-type: none"> ● Screws and pipes 	Daily, Occasionally	Check screws and pipes for looseness and oil leak.

■ Cleaning and replacement

Item	Operation cycle	Method
<ul style="list-style-type: none"> ● Replacement of oil tank and oil <ul style="list-style-type: none"> • Oil replacement 	Yearly	Replace hydraulic oil periodically. If the oil is used without replacement for a long period, it has bad influences on operation and service life of the hydraulic unit.
<ul style="list-style-type: none"> ● Cleaning of oil cooler and core 	Yearly	Disassemble and clean the oil cooler and the core according to the maintenance procedure on p. 38 and p. 39.
<ul style="list-style-type: none"> ● Oil filling port (Air breather) 	Yearly	Disassemble and clean the oil filling port (air breather) according to the maintenance procedure on p. 40.
<ul style="list-style-type: none"> ● Suction strainer 	Yearly	Disassemble and clean the suction strainer according to the maintenance procedure on p. 40.

▲ DANGER

- [1] Do not access or touch rotating parts.
- [2] If you touch internal components of the controller, observe the following procedure to prevent electric shock.
- i) Turn OFF the hydraulic unit main power supply.
(Turn OFF the power supply circuit breaker.)
To prevent erroneous operation during work, post an "Operation Prohibited (During Work)" sign on the power supply circuit breaker.
 - ii) Remove the controller cover after elapse of at least five minutes.
The controller uses a large-capacitance capacitor. If you work with the capacitor charged, you may get electric shock. Before removing the controller cover, be sure to leave the controller for **at least five minutes** to discharge electricity from the capacitor.
- [3] Before turning ON the power supply to start operation, mount all covers to the controller.

■ Oil cooler maintenance procedure

▲ WARNING

[1] Before maintenance work, stop operation, and turn OFF the main power supply.
 [2] During work, wear protective goggles and gloves.
 i) The core fin has a sharp edge. Be careful not to hurt yourself.
 ii) During air blow, be careful that foreign bodies will not touch your eyes.

▲ CAUTION

[1] During maintenance, be careful not to apply strong force to the AC fan power supply cable and connector.
 [2] During disassembly process, oil will flow out of the pipes and oil cooler.

1. Dismounting the oil cooler
 - [1] Remove the hose bands (at two places), and disconnect the hoses (two pieces) at the top of the oil cooler.
 - Note) In this step, oil may leak due to backward oil flow from the tank.
 Before conducting this step, attach a blind plug to each hose.
 - [2] Remove the hexagon socket head bolts (M5 x L16: 2 pieces) with washers, and dismount the oil cooler.
 - [3] Cut and remove the plastic strap that ties the fan harness to the AC fan.

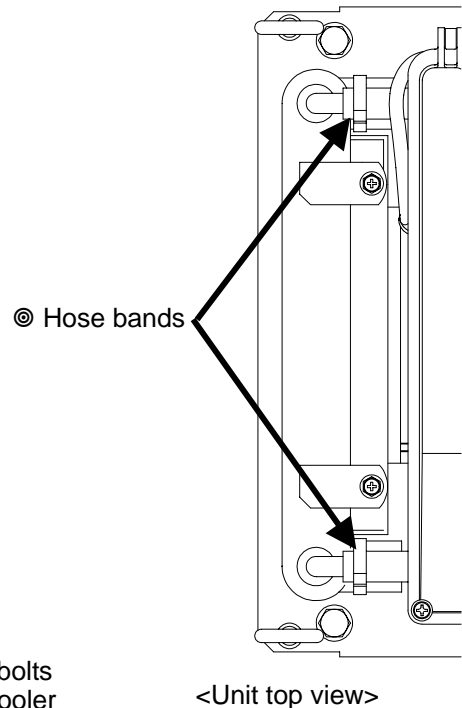
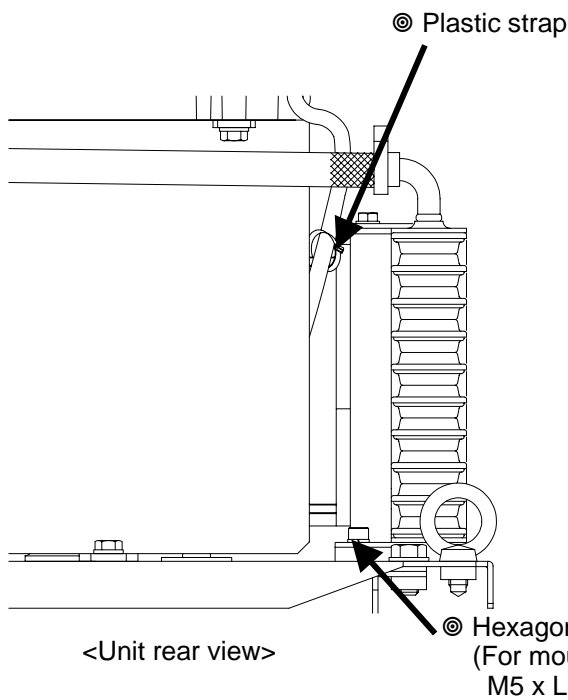
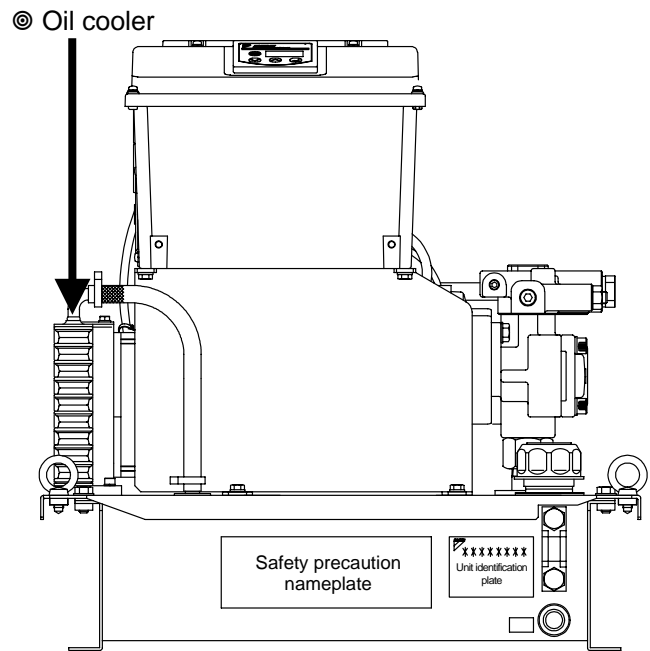

2. Disassembling the oil cooler

- [1] Remove the cross recessed hexagon head bolts (M5 x L12: 4 pieces), and separate the shroud from the core.
- [2] Remove the cross recessed head machine screws (M4 x L70: 4 pieces), and separate the shroud and the finger guard from the AC fan.

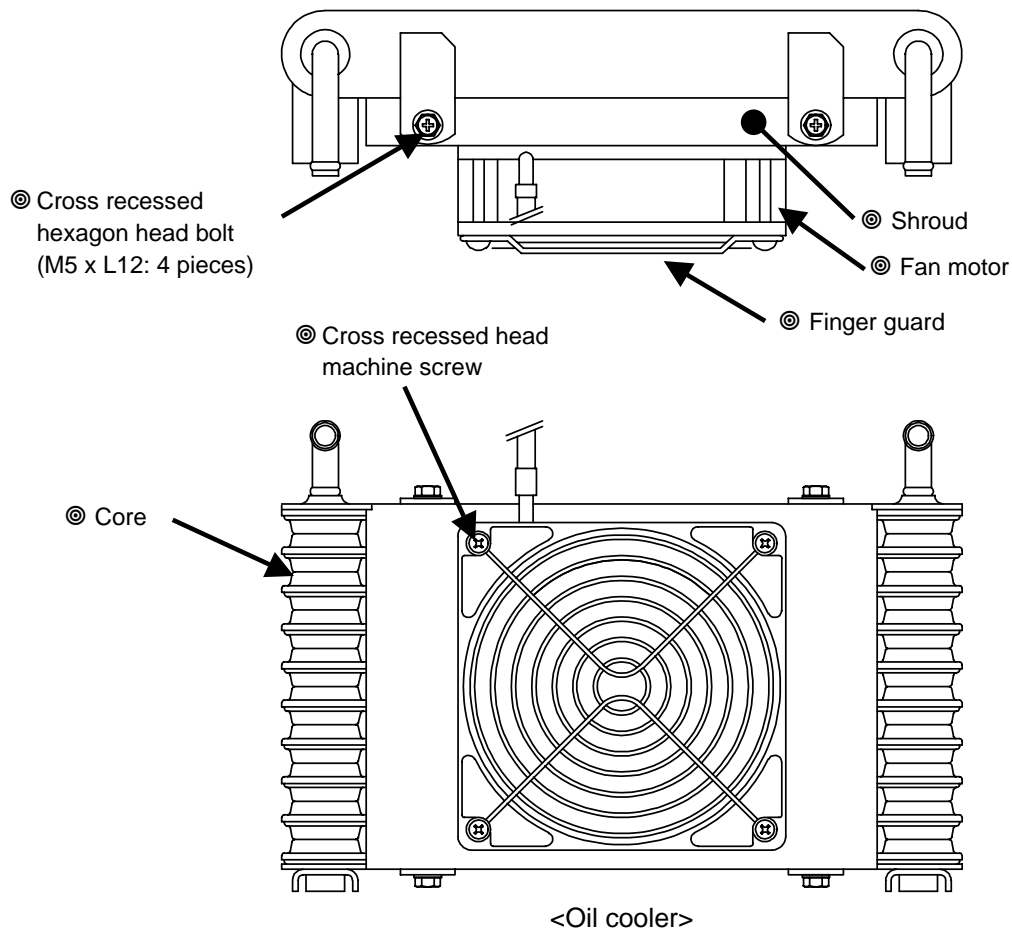

3. Cleaning the core

Blow air or steam onto the core, and clean the fins by blowing off dust accumulated on/adhering to the fins. When cleaning the fins, be careful that the dust blown away will not enter the core.

4. Cleaning the AC fan

Clean the clearance between the blade periphery and the casing, as well as the blades and the casing, by using a cloth.

▲ CAUTION

[1] Prohibition of steam/air blow

- Never attempt to blow steam or air onto the fan motor. Steam/air blow causes foreign bodies to be blown into the motor.

5. Reassembling the oil cooler

After cleaning is completed, reassemble the oil cooler.

After reassembling is completed, conduct the test run procedure described on p. 24 to make sure that the hydraulic unit normally operates.

Check if the oil cooler air intake/exhaust direction is correct. (See p. 13)

Oil filling port (air breather) maintenance procedure

1. Removing procedure
The cap can be easily removed by turning it counterclockwise by hand.
2. Cleaning procedure
Blow air onto the filter to blow off dust accumulated on/adhering to the filter.
Remove dust from inside of the strainer cylinder.
3. Mounting direction
Mount the cap by turning it clockwise by hand until it stops.

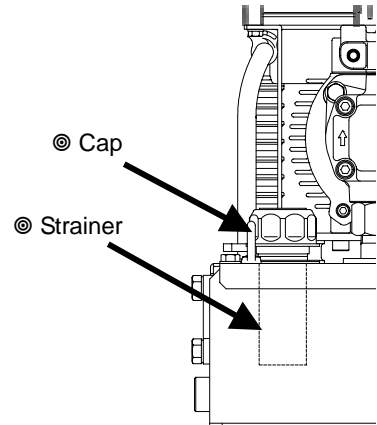

▲ WARNING

- During air blow, wear protective goggles to prevent accumulated substances or dust from touching your eyes.

Suction strainer maintenance procedure

1. Removing procedure
 - [1] After draining hydraulic oil completely, remove the hexagon bolts (M8 x 16L: 4 pieces) that fastens the tank to the top plate.
 - [2] Lift the top plate by the hook holes to separate the top plate from the tank.
 - [3] You can see the suction strainer. Loosen the strainer, and remove it.
2. Cleaning procedure
Blow air onto the filter to blow off dust accumulated on/adhering to the filter.
Remove dust from inside of the strainer cylinder.
3. Reassembling the strainer
After cleaning is completed, reassemble the suction strainer. Follow the removing procedure in reverse.
After reassembling is completed, conduct the test run procedure described on p. 24 to make sure that the hydraulic unit normally operates.

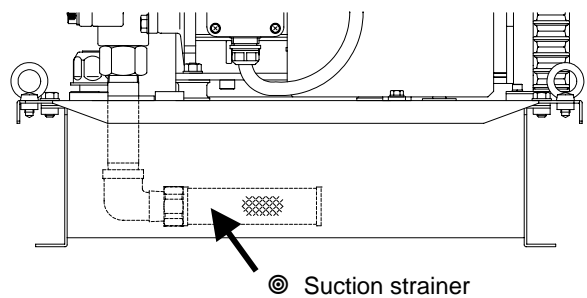
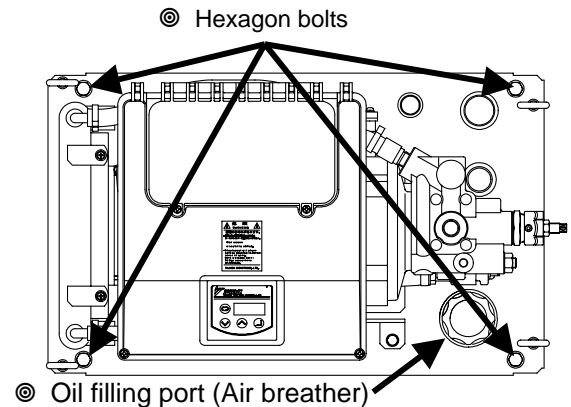

▲ DANGER

- If the hydraulic unit is lifted by any parts (e.g. pump piping) other than the hook holes, the unit may fall or turn over.
- Check the weight of the hydraulic unit, and make sure that it does not exceed the rated load capacity of each lifting sling.

▲ WARNING

- During air blow, wear protective goggles to prevent accumulated substances or dust from touching your eyes.
- During transportation, make sure that the unit can be evenly lifted by the hook holes at four places.
- During transportation using lifting slings, never come close to the unit. If the unit falls or turns over, you may suffer from injury.

▲ CAUTION

- When the top plate is lifted, oil drips. Pay attention to oil drips.

[Attachment: Safety Valve Adjustment Procedure]

In any of the following three cases, readjust the safety valve by referring to the “Safety valve adjustment procedure”.

1. Conditions that need safety valve setting readjustment:

Even if the unit is operated with the maximum pressure setting, the safety valve will not be activated under the normal pressure control status (except for a transient period when the circuit is blocked during stop of the hydraulic actuator for the main unit). However, during long-term repeated operations of the unit, or because of contaminants in hydraulic oil, the preset pressure of the safety valve may decrease, causing the safety valve to be activated even in normal conditions.

[Judgment criteria]

- The hydraulic oil temperature quickly increases as compared with the conventional case.
- When an rpm value is displayed in a pressure-holding condition, the indicated rpm value decreases as the safety valve adjusting screw is turned in the tightening direction.

2. To minimize surge pressure extremely higher than a preset pressure, in consideration of withstanding pressure of the hose being used.

3. When the pressure setting of the safety valve has been changed from the DAIKIN factory-set value:

To protect the actuator for the main unit and peripheral equipment such as pressure gauges, it is recommended that the safety valve pressure setting should be “Preset pressure of the unit + 0.5 MPa”.

⚠ CAUTION

- During operation under 6 MPa or higher PC pressure setting, if the pressure becomes unstable due to contaminant or for other reasons, mount **the fixed restrictor (φ0.8)** included in this unit.
- Before mounting the fixed restrictor, make sure that there is no residual pressure in the unit.

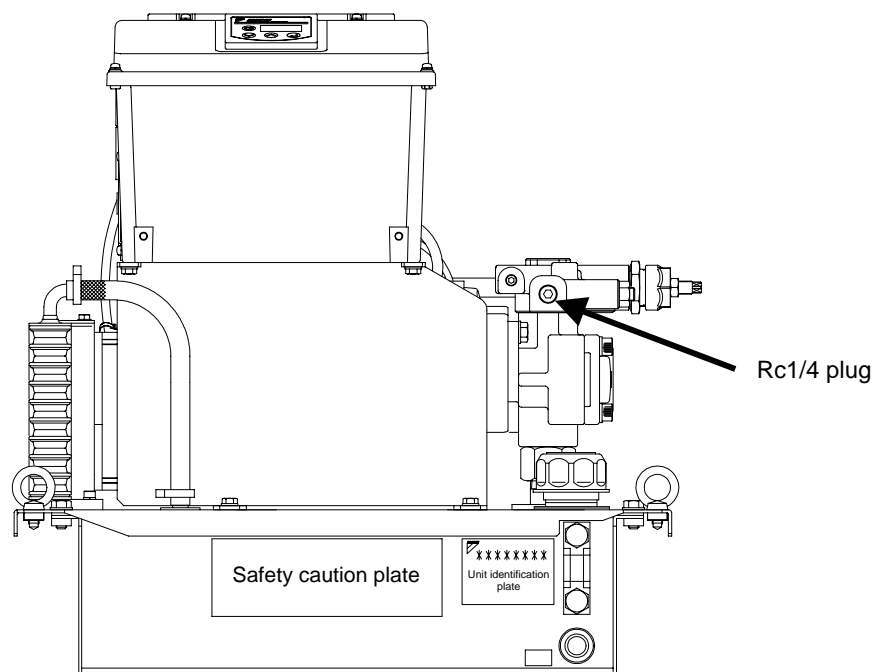

◆ Fixed restrictor (φ0.8) mounting procedure

- 1) Remove the hexagon socket head taper plug (Rc1/4).
- 2) Mount the fixed restrictor (NPTF1/16 × φ0.8).
- 3) Remount the hexagon socket head taper plug (Rc1/4) by winding sealing tape on it.

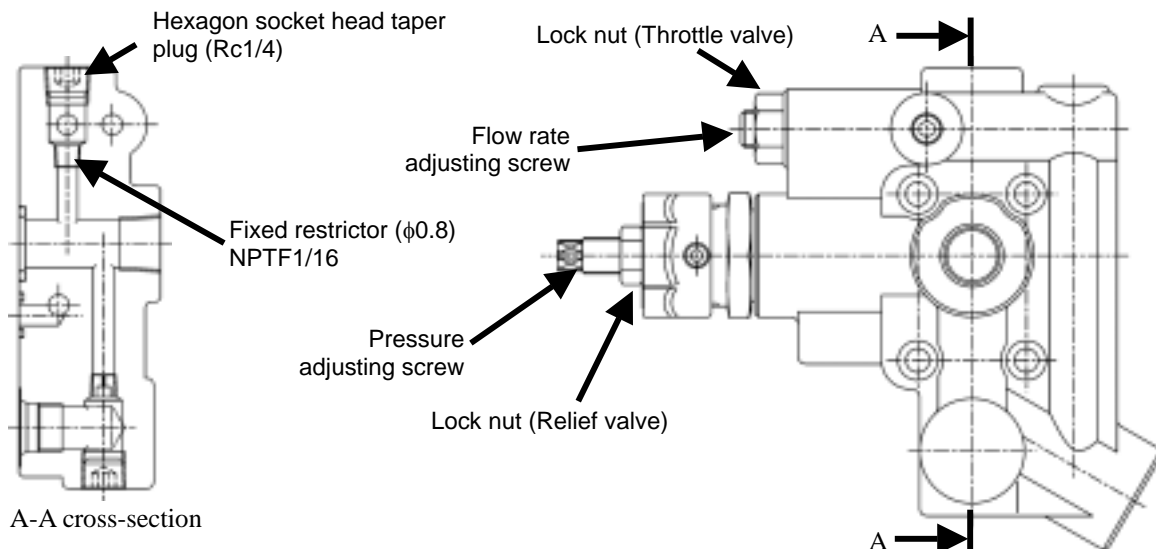

<Safety valve adjustment procedure>

- 1) Loosen the lock nut (M10, Width across flat: 14 mm) by referring to the enlarged view of the safety valve. (See the figure below.)
- 2) Set the screw length corresponding to the target control pressure, by referring to the graph of standard pressure adjusting screw length. (The tip of the adjusting screw has four chamfered faces with 7 mm width.)
- 3) Turn ON the power supply for the hydraulic unit, and select the setting mode with the panel key to set the pressure at a target level.
- 4) Select [n05] (rpm display) in the monitor mode with the panel key to show the current rpm value.
- 5) Adjust the pressure adjusting screw length forward/backward, to find the activation starting point as shown on the right.
- 6) Tighten the pressure adjusting screw clockwise by 3/4 turn from the activation starting point.
- 7) Tighten the lock nut. This completes the adjusting procedure.

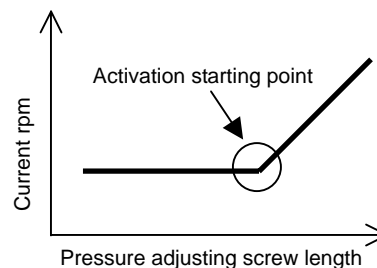

(When tightening the lock nut, be careful not to turn the adjusting screw.)

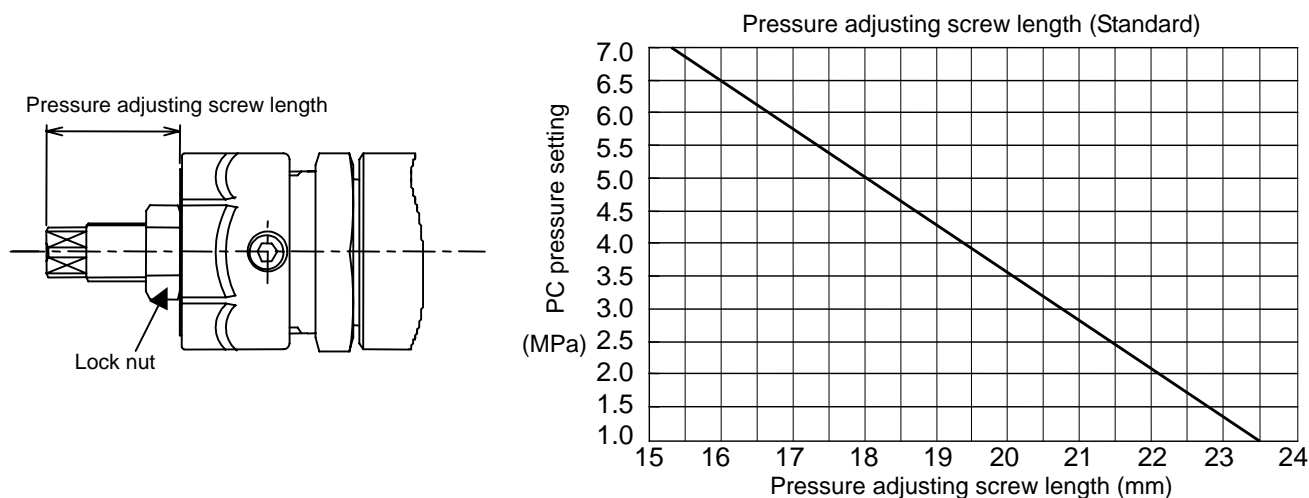

<Minimum rpm adjustment procedure>

According to a change in pressure set value, the rpm value will also change. Adjust rpm to an appropriate value.

Minimum rpm: rpm value confirmed before change of PC pressure setting (350 min^{-1} or more)

- 1) Select [n05] (rpm display) in the monitor mode with the panel key to show the current rpm value.
- 2) Loosen the lock nut for the minimum rpm adjusting throttle valve.
- 3) While checking the actual rpm value indicated on the display, adjust the throttle valve.
(Turning the throttle valve clockwise reduces the rpm value. Turning the valve counterclockwise increase the rpm value.)
- 4) Tighten the lock nut. This completes the adjusting procedure.
(When tightening the lock nut, be careful not to turn the adjusting screw.)

[Attachment: Power-ON External I/O Signal Timing Chart]

1. When parameter [P08] is "0"

1-1 When the pressure switch function is not used

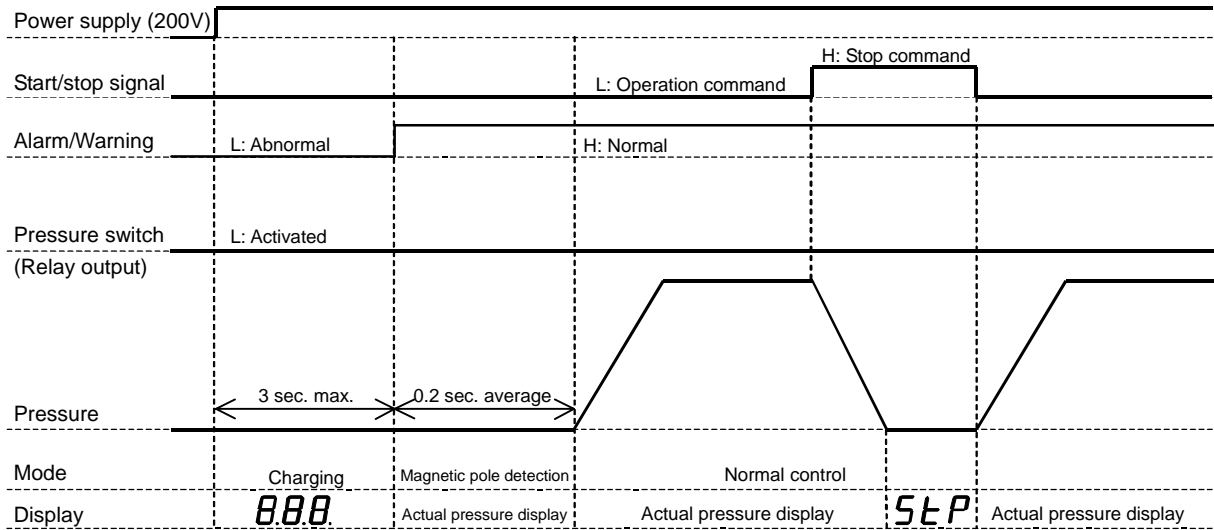

1-2 When the pressure switch function is used

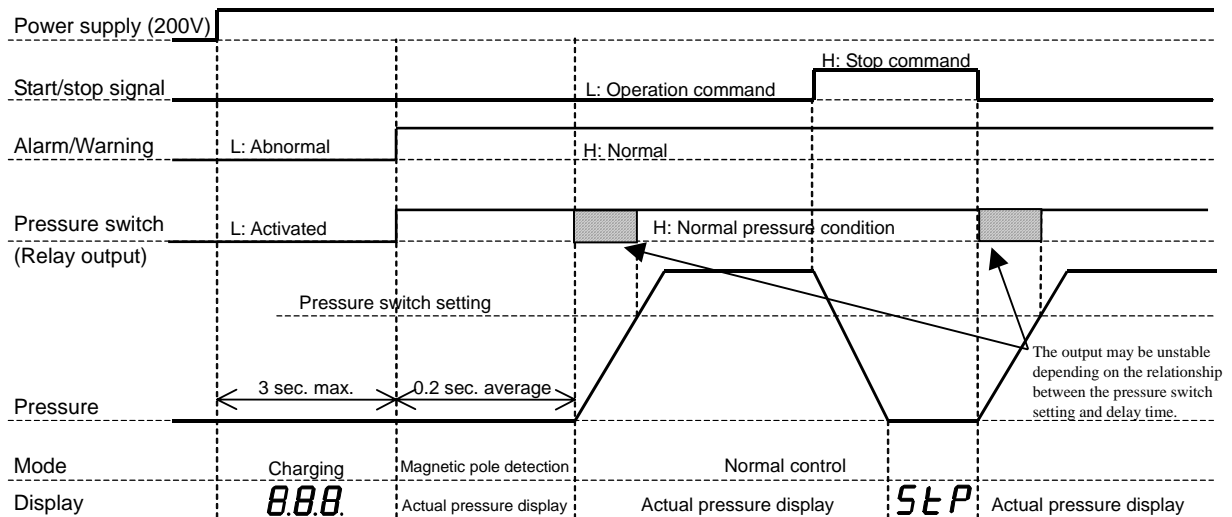

1-3 When the pressure switch function is used (Stop at power-ON)

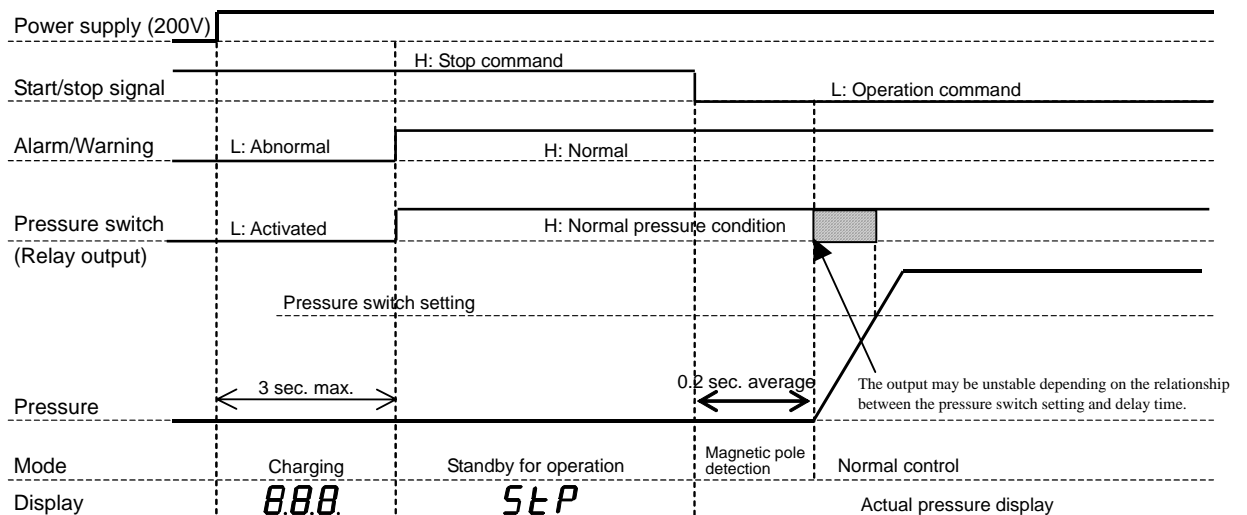

* Magnetic pole detection will be executed at the first motor startup after power-ON.

1-4 Alarm classification [1]

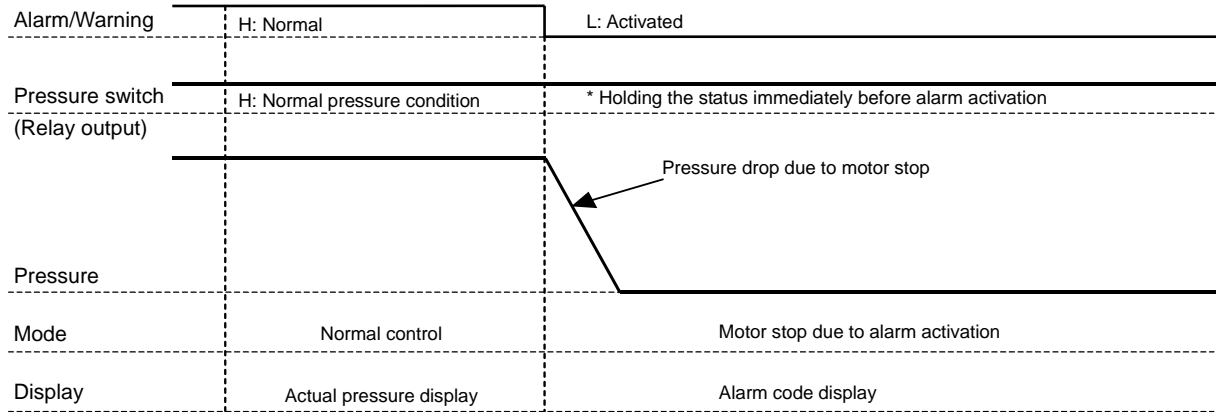

1-5 Alarm classification [2]

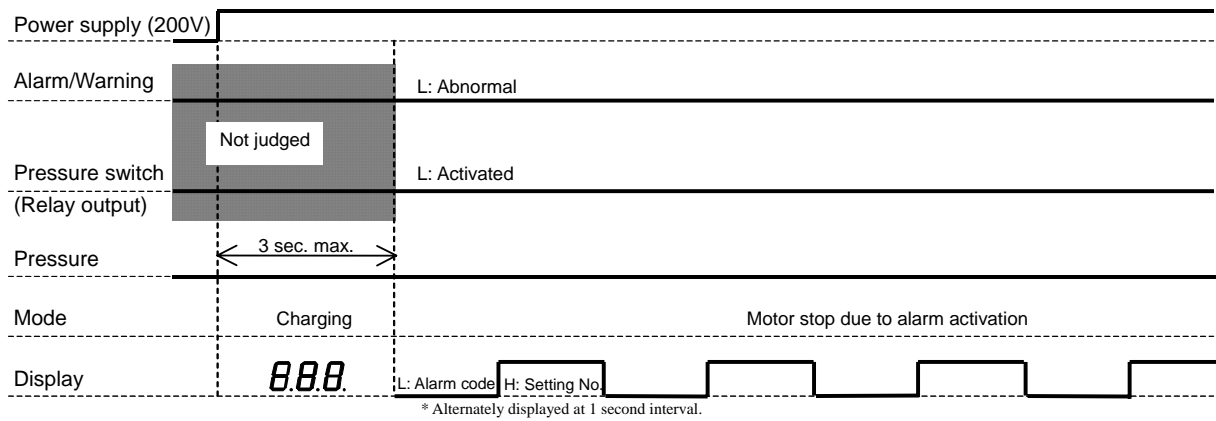

1-6 Alarm classification [3]

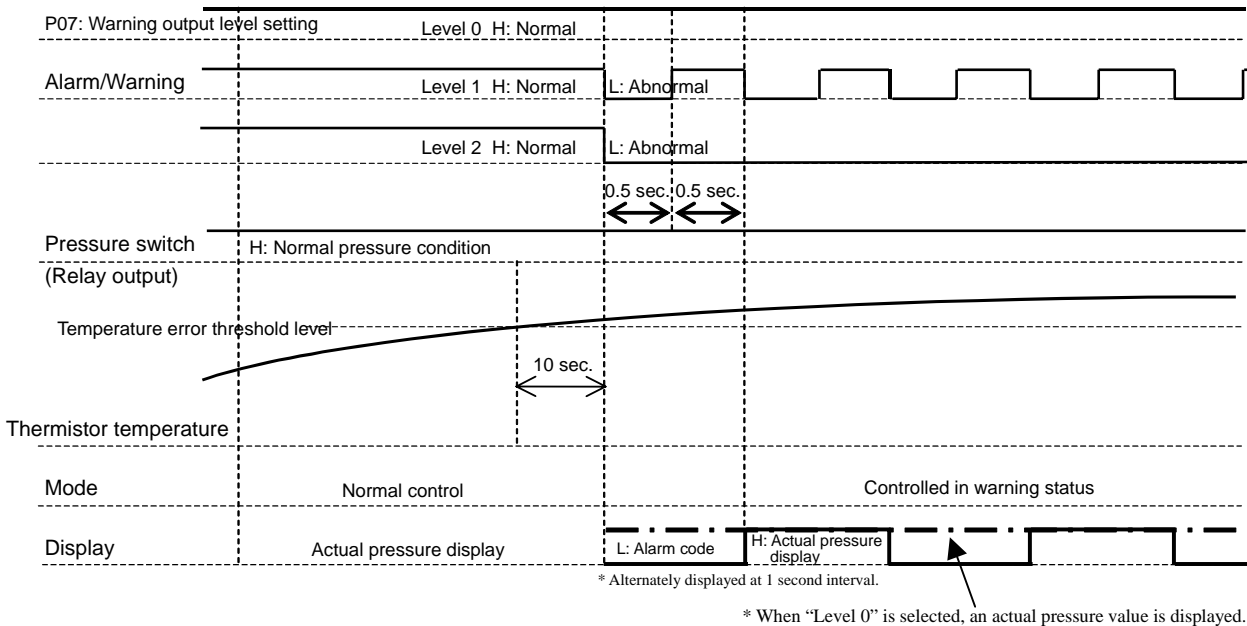

1-7 Alarm classification [4]

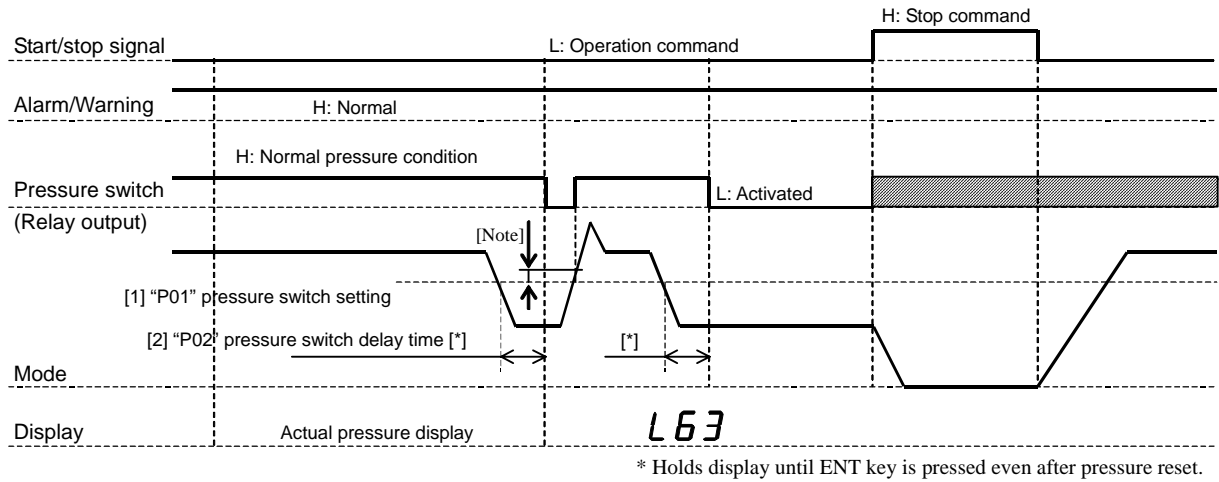

The above chart shows the case where “P03” (Pressure switch display hold setting) is [1] or [2].

When “P03” is [0], an actual pressure value is displayed.

When the stop command is activated by the start/stop signal, the pressure switch is in the normal condition.

The “P01” and “P02” settings (above [1] and [2]) can be changed in the setting mode.

For the setting procedure and setting range, see “Operating procedure for each mode: b) Setting mode” on p. 26.

Note) For the purpose of explanation, the above “1-7 Alarm classification [4]” chart shows the case where the pressure switch is activated without a dead zone.

Actually, however, the pressure switch has a dead zone of approx. 0.5 MPa.

2. When parameter [P08] is "1"

2-1 When the pressure switch function is not used

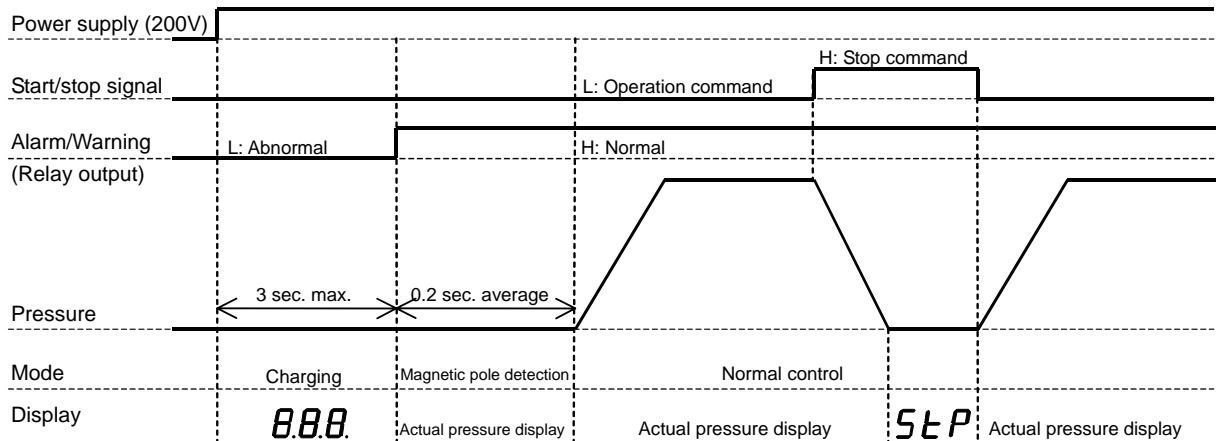

2-2 When the pressure switch function is used

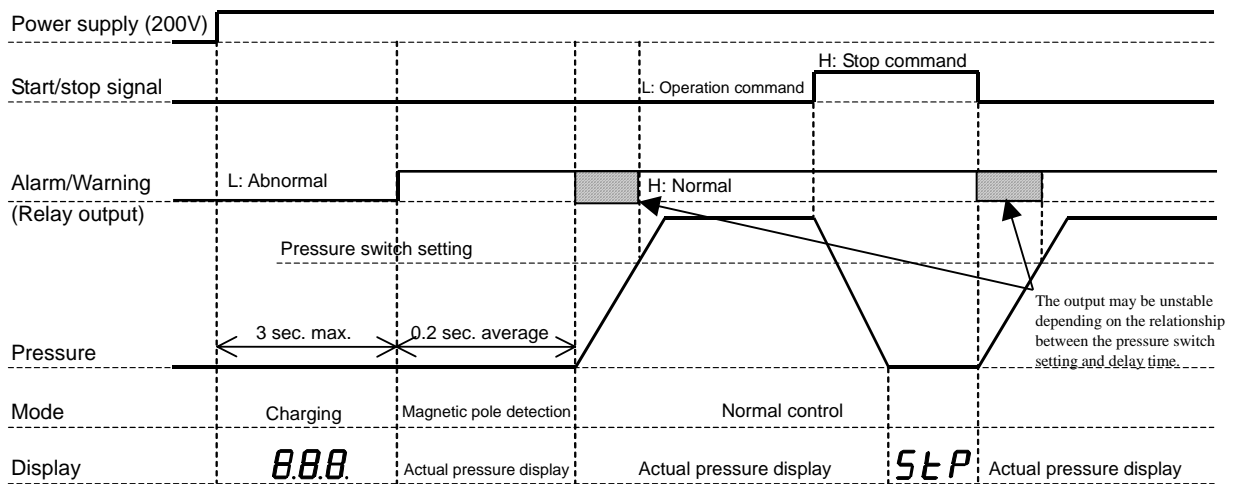

2-3 When the pressure switch function is used (Stop at power-ON)

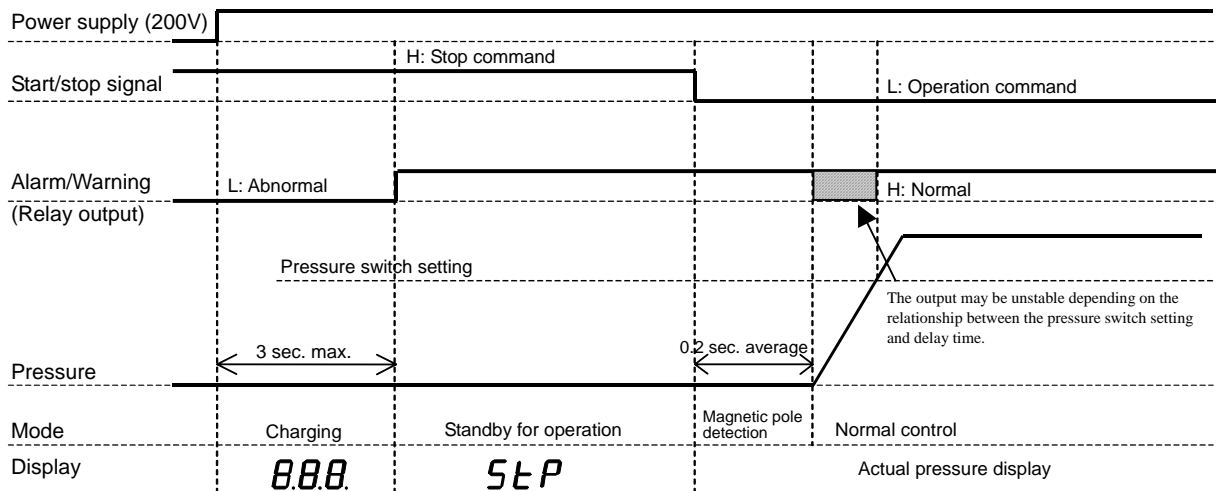

* Magnetic pole detection will be executed at the first motor startup after power-ON.

2-4 Alarm classification [1]

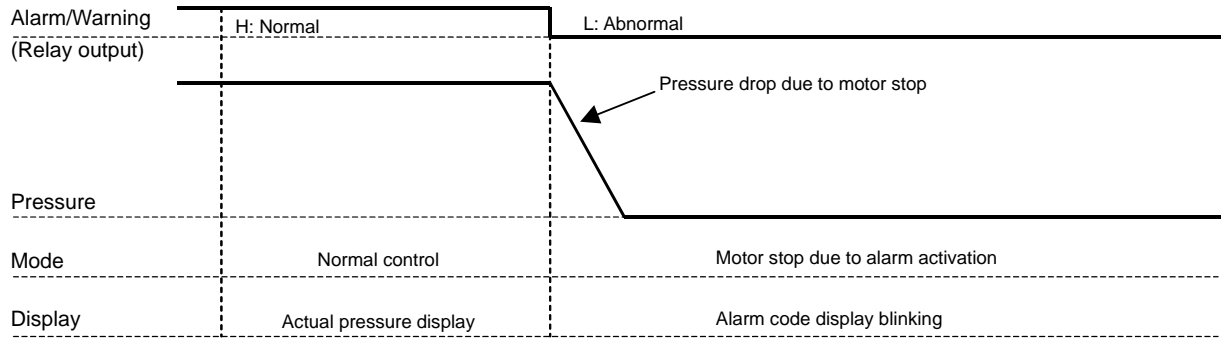

2-5 Alarm classification [2]

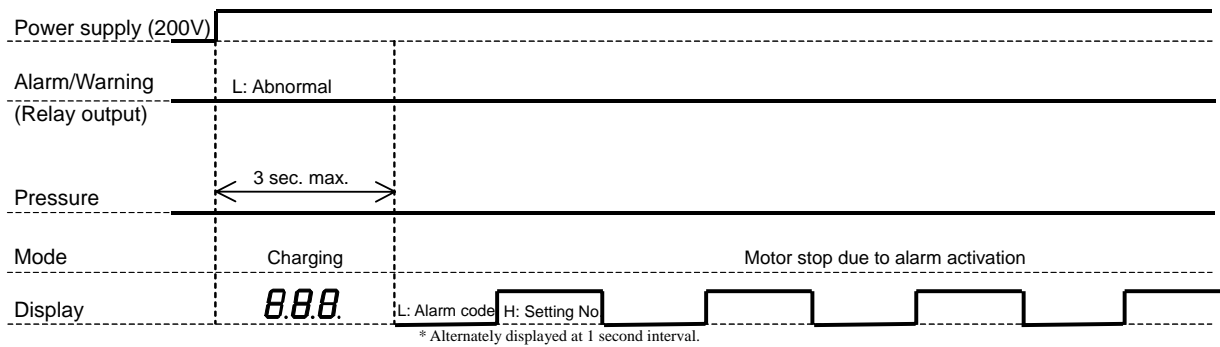

2-6 Alarm classification [3]

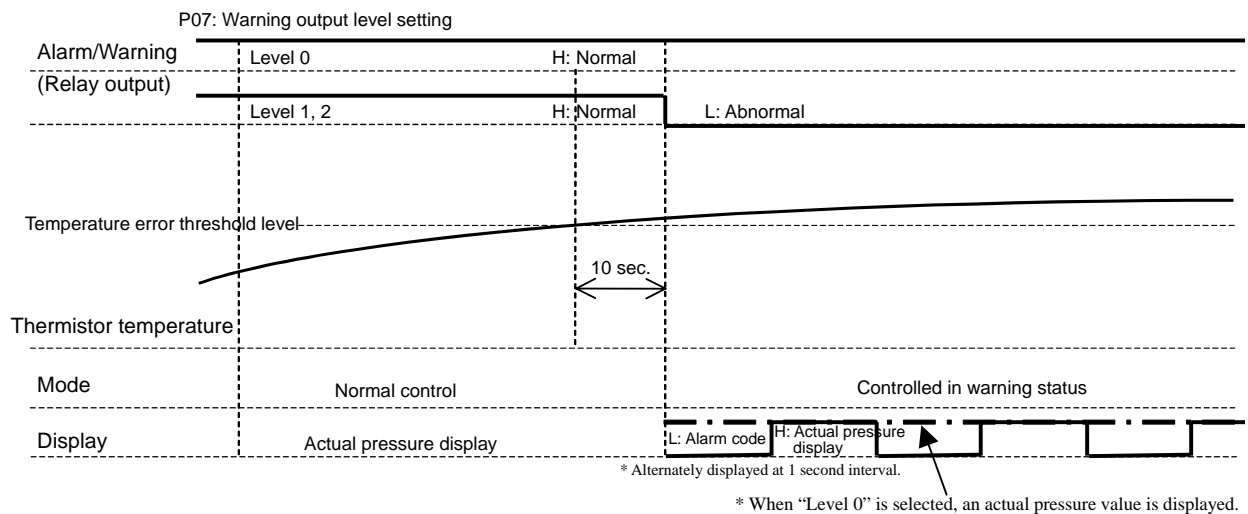

2-7 Alarm classification [4]

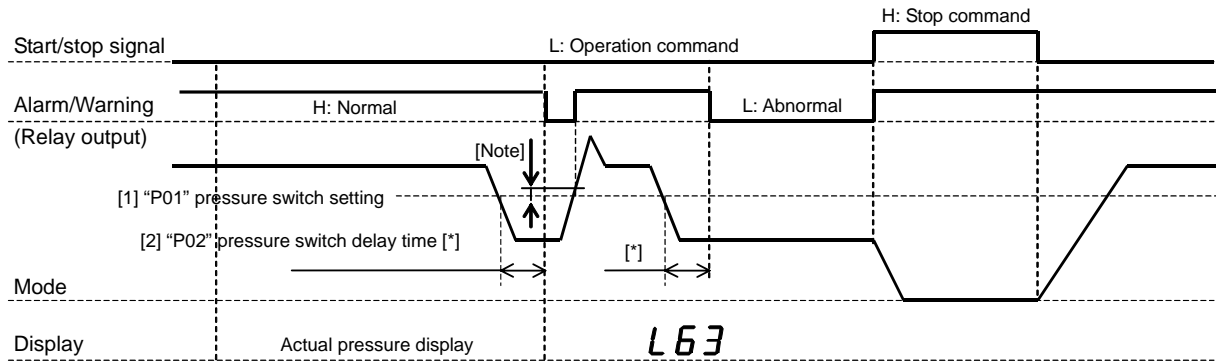

The above chart shows the case where “P03” (Pressure switch display hold setting) is [1] or [2].

When “P03” is [0], an actual pressure value is displayed.

When the stop command is activated by the start/stop signal, the pressure switch is in the normal condition.

The “P01” and “P02” settings (above [1] and [2]) can be changed in the setting mode.

For the setting procedure and setting range, see “Operating procedure for each mode: b) Setting mode” on p. 26.

Note) For the purpose of explanation, the above “2-7 Alarm classification [4]” chart shows the case where the pressure switch is activated without a dead zone.

Actually, however, the pressure switch has a dead zone of approx. 0.5 MPa.

3. Contact I/O timing chart

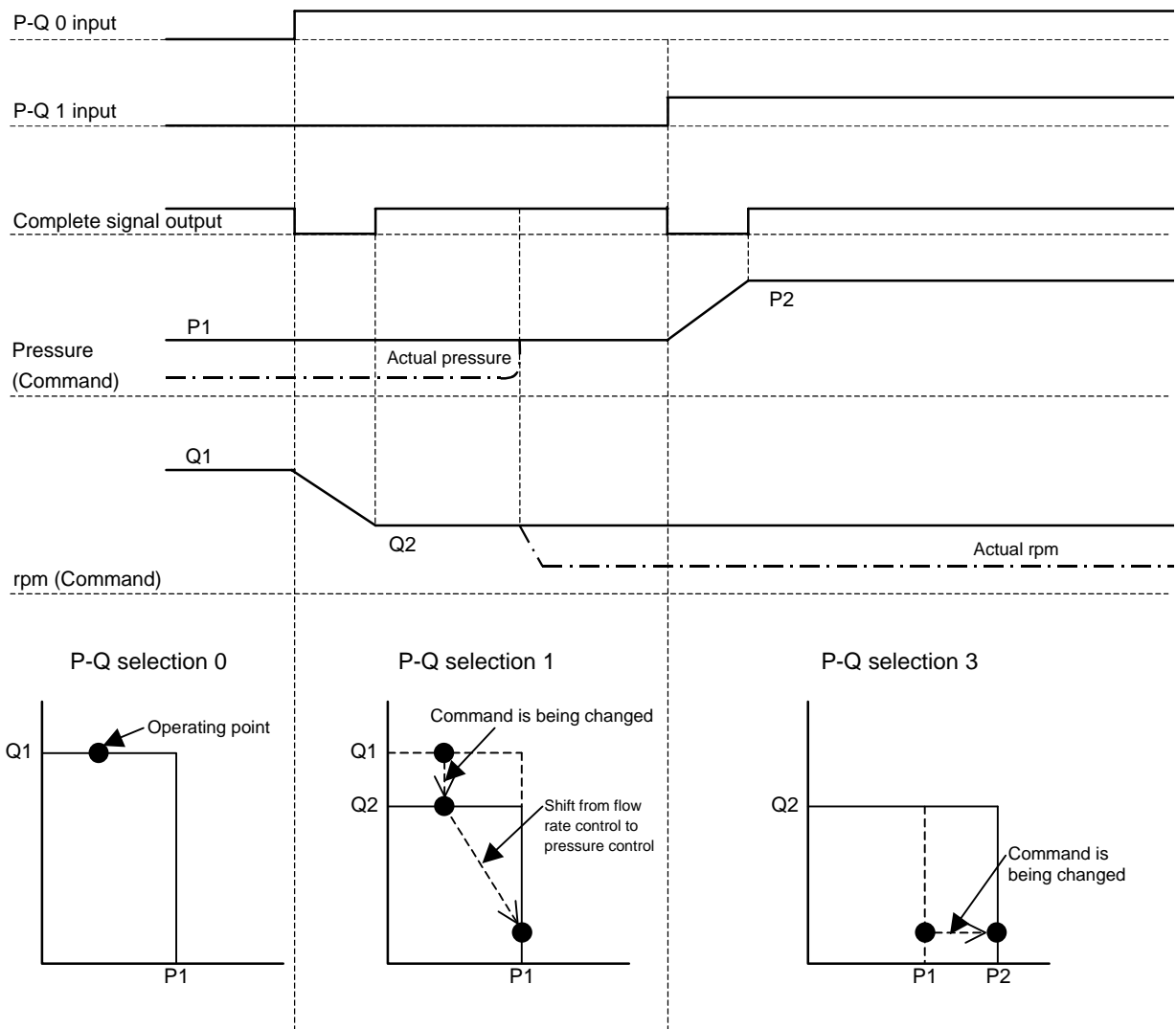

- When the command value is being changed according to a change in P-Q selection No., the complete signal status is “Lo”. When the command value does not change any more, the complete signal status is changed to “Hi”.